

ICON

FACIAL PLATING SYSTEM

PRODUCT CATALOG



Table of Contents

System Introduction	4-5
System Components	6-85
System Overview	6-7
1.2mm Plating Module	8
1.2mm Plates	9-10
1.2mm Additional Plates	10-12
1.2mm Additional Orbital Plates	13
1.2mm Screws	14
1.2mm Instruments	16
1.2mm Additional Instruments	16
1.6mm Plating Module.....	16-17
1.6mm Trauma Plates.....	18-19
1.6mm Orthognathic Plates.....	19-20
1.6mm OSA LeFort Plates	21-22
1.6mm Additional Plates.....	22-25
1.6mm Additional Orbital Plates	26
1.6mm Screws	27
1.6mm Instruments.....	28
1.6mm Additional Instruments.....	29
2.0mm Plating Module.....	30-31
2.0mm Trauma Plates.....	32-33
2.0mm Orthognathic Plates.....	33-34
2.0mm OSA LeFort Plates	34-35
2.0mm Additional Plates.....	35-40
2.0mm Screws.....	41-42
2.0mm Instruments	43
2.0mm Additional Instruments.....	44
2.0/2.4mm Angled Locking Plating Module	46-47
1.0mm Profile Plates.....	48-49
Additional 1.0mm Profile Plates	49-50
1.5mm Profile Plates.....	51
Additional 1.5mm Profile Plates	52
2.0mm Recon Plates.....	52-53
2.0mm Locking Screws	54-55
2.4mm Locking Screws	56-57
2.0/2.4mm Instruments	58
2.0/2.4mm Additional Instruments.....	59
Recon Plating Module.....	60-61
2.8mm Recon Plates	62-65
2.0mm Locking Screws	66-67
2.4mm Locking Screws	68-69
Recon Instruments.....	70
Additional Recon Instruments.....	71
Utility Tray.....	72
Auxiliary Tray	72
Custom ID Tags	73
General Instruments	74-77
Mid-Face Instruments	78-81
Mandibular Instruments.....	82-85
Additional Instruments.....	85
Index	86-95



Rethinking Possibilities, Reshaping Lives

For more than two decades, OsteoMed has remained sharply focused on meeting the needs of surgeons and their patients by rethinking clinical possibilities with a focus on procedural efficiency, efficacy and uncompromised quality.

A highly nimble and responsive company, OsteoMed is a leading global innovator, developer, manufacturer and marketer of specialty medical devices, surgical implants and powered surgical instruments.

Our success is driven by the ability to quickly develop and deliver innovative, quality products focused on improving patient outcomes and offer simple and cost-effective solutions for surgeons, hospitals and patients.





ICON

FACIAL PLATING SYSTEM

Improved. Customizable. Optimized. New.

OsteoMed's exciting new plating set includes all the features of a comprehensive CMF trauma system with the ability to customize for each customer's needs. ICON™ upgrades include improved instrumentation, integrated mesh drawer, and multipurpose auxiliary tray. The entire system is housed in a lighter-weight, sleeker case with intuitive plating blocks and screw modules.

SYSTEM OVERVIEW

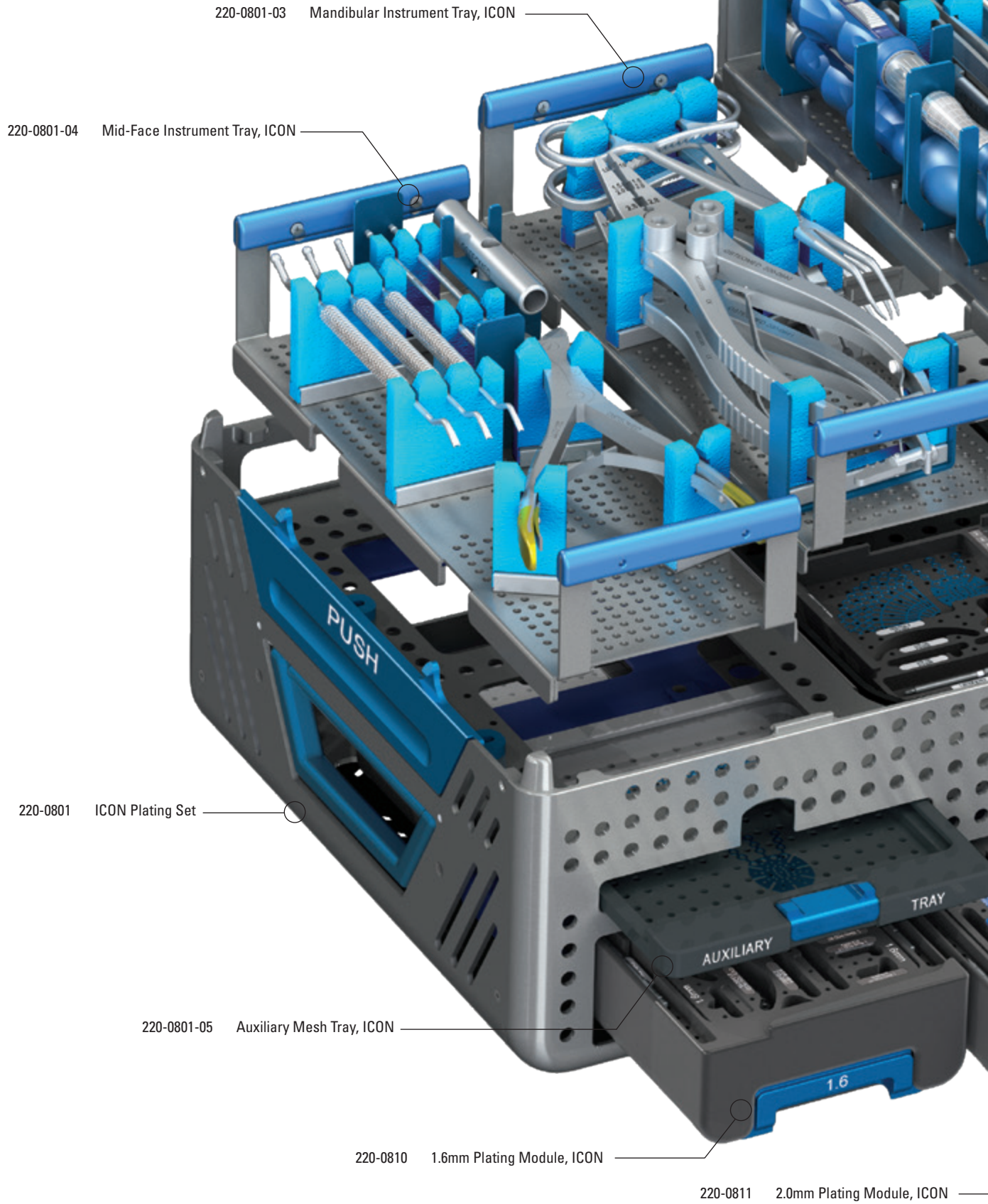

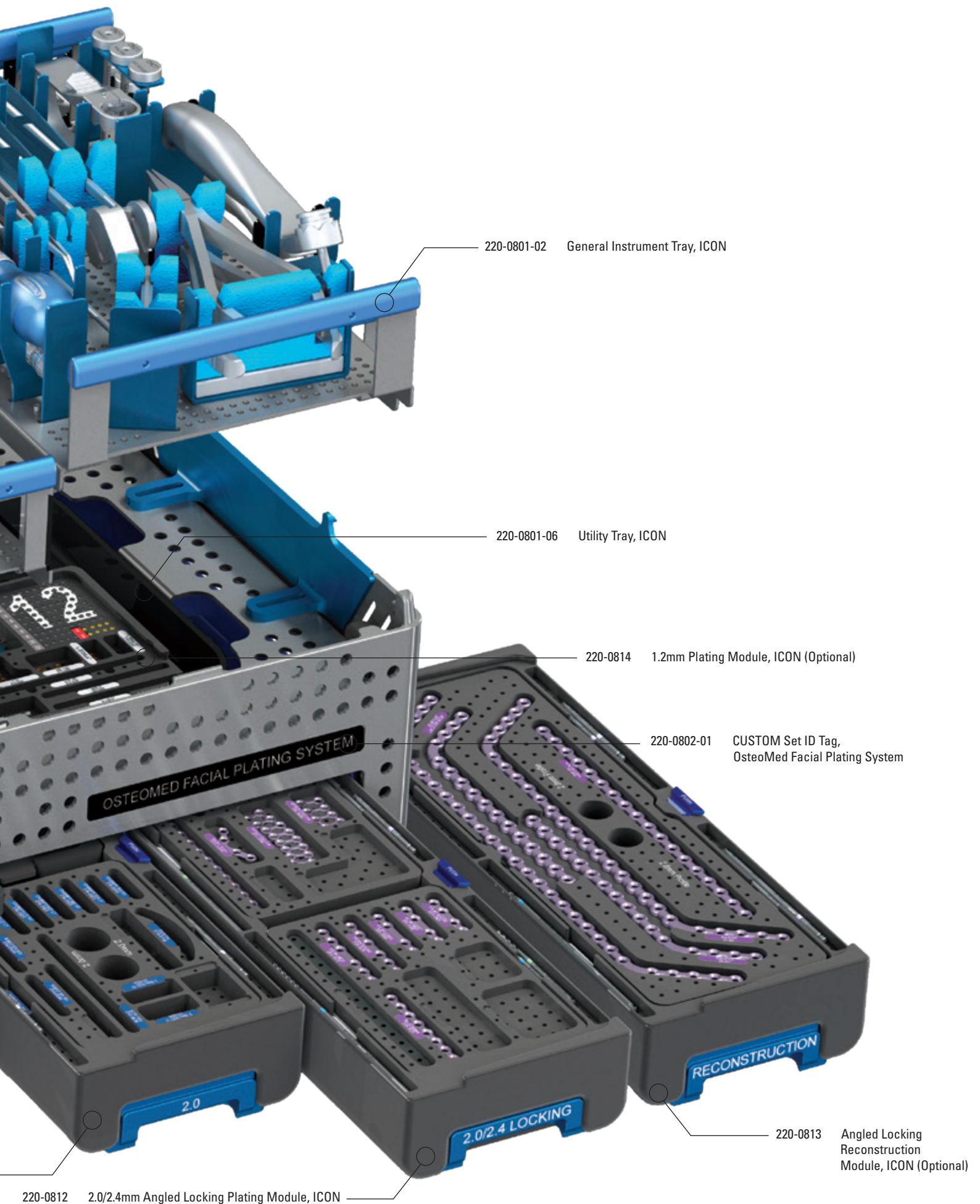



1.2 PLATING MODULE



220-0814 1.2mm Plating Module, ICON

1.2mm PLATING MODULE

*Optional; can be added to the Utility Tray under the instrument racks

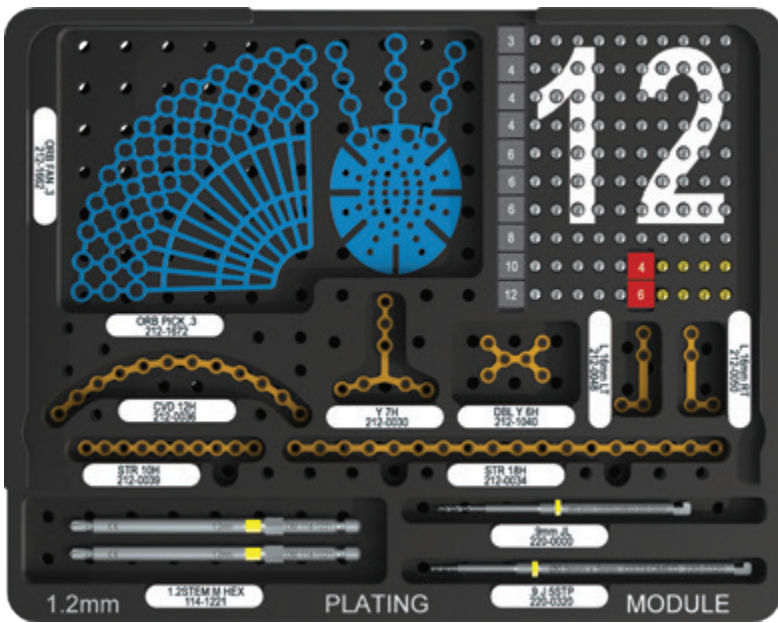

220-0814 1.2mm Plating Module, ICON

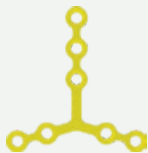

212-0030
7 Hole "Y" Plate



220-0641-01
Plate Tag - Y 7H



212-0034
18 Hole Straight Plate



220-0641-04
Plate Tag - STR 18H



212-0036
12 Hole Curved Plate



220-0641-05
Plate Tag - CVD 12H



212-0039
10 Hole Straight Plate



220-0641-07
Plate Tag - STR 10H



212-0048
16mm Left "L" Plate



220-0641-13
Plate Tag - L 16mm LT



212-0050
16mm Right "L" Plate



220-0641-14
Plate Tag - L 16mm RT



212-1040
Micro 6 Hole Double "Y"
Plate



220-0641-34
Plate Tag - DBL Y 6H

1.2mm PLATING MODULE

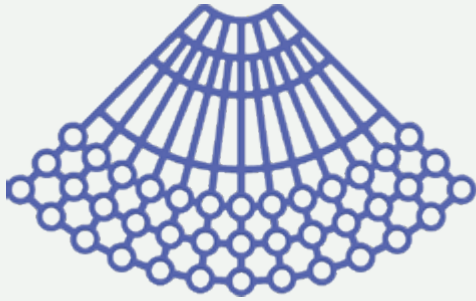

212-1662
1.2mm Orbital Floor Plate,
Fan, .3mm Thick

ORB FAN .3
212-1662

220-0641-59
Plate Tag - ORB FAN .3

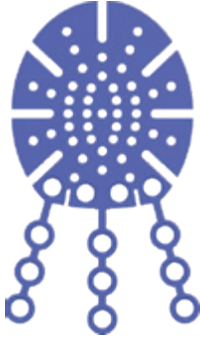

212-1672
1.2mm Orbital Floor Plate,
Pick, .3mm Thick

ORB PICK .3
212-1672

220-0641-63
Plate Tag - ORB PICK .3

ADDITIONAL 1.2mm PLATES

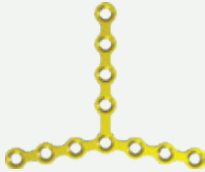

212-0031
11 Hole "Y" Plate

Y11H
212-0031

220-0641-02
Plate Tag - Y11H



212-0032
"H" Plate

H
212-0032

220-0641-03
Plate Tag - H



212-0038
5 Hole Straight Plate

STR 5H
212-0038

220-0641-06
Plate Tag - STR 5H



212-0040
2 x 4 Hole Quad Plate

QUAD 2X4H
212-0040

220-0641-08
Plate Tag - QUAD 2X4H

ADDITIONAL 1.2mm PLATES



212-0041
Short 2 x 4 Hole Quad Plate

QUAD 2X4H SH
212-0041

220-0641-09
Plate Tag - QUAD 2X4H SH

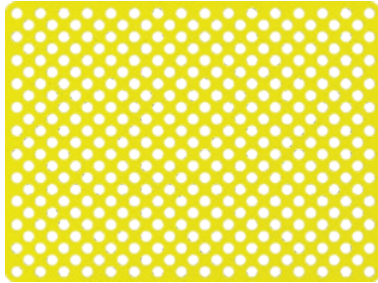

212-0042
37 x 50mm Mesh Plate

MESH 37X50mm
212-0042

220-0641-10
Plate Tag - MESH 37X50mm



212-0044
13mm Left "L" Plate

L 13mm LT
212-0044

220-0641-11
Plate Tag - L 13mm LT



212-0046
13mm Right "L" Plate

L 13mm RT
212-0046

220-0641-12
Plate Tag - L 13mm RT



212-0052
19mm "T" Plate

T 19mm
212-0052

220-0641-15
Plate Tag - T 19mm



212-0068
"X" Plate

X
212-0068

220-0641-18
Plate Tag - X



212-0069
Medium 2 x 4 Hole
Quad Plate

QUAD 2X4H MD
212-0069

220-0641-19
Plate Tag - QUAD 2X4H MD



212-0080
Orbital Plate

ORBITAL
212-0080

220-0641-20
Plate Tag - ORBITAL

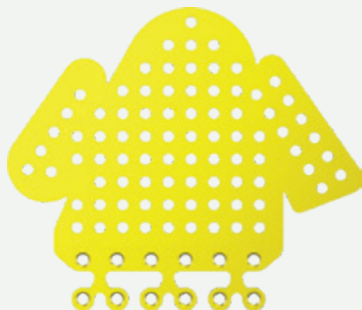

212-0086
Orbital Floor Plate, Large

ORBITAL LRG
212-0086

220-0641-21
Plate Tag - ORBITAL LRG

ADDITIONAL 1.2mm PLATES

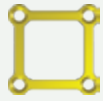

212-0134
Square Plate

SQUARE
212-0134

220-0641-24
Plate Tag - SQUARE

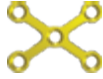

212-0136
Extended "X" Plate

EXT X
212-0136

220-0641-25
Plate Tag - EXT X



212-0138
Extended Double "Y" Plate

EXT DBL Y
212-0138

220-0641-26
Plate Tag - EXT DBL Y



212-1030
Micro 4 Hole Straight Plate

STR 4H
212-1030

220-0641-32
Plate Tag - STR 4H



212-1032
Micro 8 Hole Straight Plate

STR 8H
212-1032

220-0641-33
Plate Tag - STR 8H

ADDITIONAL 1.2mm ORBITAL PLATES

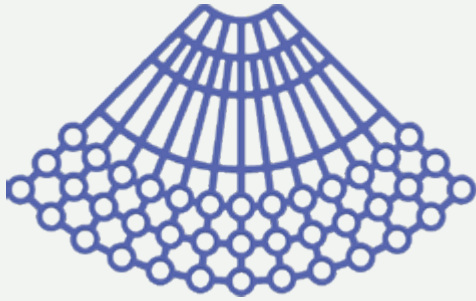

212-1661
1.2mm Orbital Floor Plate,
Fan, .2mm Thick

ORB FAN .2
212-1661

220-0641-58
Plate Tag - ORB FAN .2

212-1663
1.2mm Orbital Floor Plate,
Fan, .4mm Thick

ORB FAN .4
212-1663

220-0641-60
Plate Tag - ORB FAN .4

212-1664
1.2mm Orbital Floor Plate,
Fan, .5mm Thick

ORB FAN .5
212-1664

220-0641-61
Plate Tag - ORB FAN .5

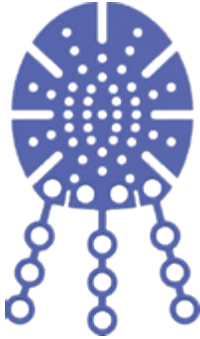

212-1671
1.2mm Orbital Floor Plate,
Pick, .2mm Thick

ORB PICK .2
212-1671

220-0641-62
Plate Tag - ORB PICK .2

212-1673
1.2mm Orbital Floor Plate,
Pick, .4mm Thick

ORB PICK .4
212-1673

220-0641-64
Plate Tag - ORB PICK .4

212-1674
1.2mm Orbital Floor Plate,
Pick, .5mm Thick

ORB PICK .5
212-1674

220-0641-65
Plate Tag - ORB PICK .5



212-1681
1.2mm Orbital Floor Plate,
Preformed, Left, .2mm Thick

ORB PREF L.2
212-1681

220-0641-66
Plate Tag - ORB PREF L.2

212-1682
1.2mm Orbital Floor Plate,
Preformed, Left, .3mm Thick

ORB PREF L.3
212-1682

220-0641-67
Plate Tag - ORB PREF L.3

212-1683
1.2mm Orbital Floor Plate,
Preformed, Left, .4mm Thick

ORB PREF L.4
212-1683

220-0641-68
Plate Tag - ORB PREF L.4

212-1684
1.2mm Orbital Floor Plate,
Preformed, Left, .5mm Thick

ORB PREF L.5
212-1684

220-0641-69
Plate Tag - ORB PREF L.5



212-1691
1.2mm Orbital Floor Plate,
Preformed, Right, .2mm Thick

ORB PREF R.2
212-1691

220-0641-70
Plate Tag - ORB PREF R.2

212-1692
1.2mm Orbital Floor Plate,
Preformed, Right, .3mm Thick

ORB PREF R.3
212-1692

220-0641-71
Plate Tag - ORB PREF R.3

212-1693
1.2mm Orbital Floor Plate,
Preformed, Right, .4mm Thick

ORB PREF R.4
212-1693

220-0641-72
Plate Tag - ORB PREF R.4

212-1694
1.2mm Orbital Floor Plate,
Preformed, Right, .5mm Thick

ORB PREF R.5
212-1694

220-0641-73
Plate Tag - ORB PREF R.5

1.2mm SCREWS

1.2mm Self Tapping Screws



P/N	Description	P/N	Description
204-1203	1.2mm x 3mm Standard Screw	220-0614-03	3
204-1204	1.2mm x 4mm Standard Screw	220-0614-04	4
204-1206	1.2mm x 6mm Standard Screw	220-0614-06	6
204-1208	1.2mm x 8mm Standard Screw	220-0614-08	8
204-1210	1.2mm x 10mm Standard Screw	220-0614-10	10
204-1212	1.2mm x 12mm Standard Screw	220-0614-12	12
204-1214	1.2mm x 14mm Standard Screw	220-0614-14	14

1.2mm Self Tapping Screw Tags



220-0614-99 TAG, SELF TAP

1.2mm Emergency Screws



P/N	Description	P/N	Description
204-1504	1.5mm x 4mm Safety Screw	220-0615-04	4
204-1506	1.5mm x 6mm Safety Screw	220-0615-06	6

1.2mm Emergency Screw Tags



220-0615-99 TAG, ER

1.2mm INSTRUMENTS

1.2mm Drills



220-0000 0.9 Pilot Drill, J-Latch

9mm JL
220-0000

220-0641-39



220-0320 0.9mm Pilot Drill, 5mm Stop, J-Latch

9 J 5STP
220-0320

220-0641-54

1.2mm Drivers



114-1221 1.2mm Driver Stem, Medium, Hex Shank

1.2STEM M HEX
114-1221

220-0641-56

ADDITIONAL 1.2mm INSTRUMENTS

1.2mm Drills



220-0001 1.0mm Pilot Drill, J-Latch

1.0MM JL
220-0001

220-0641-40



220-0011 1.0mm Pilot Drill, 4mm Stop, J-Latch

1.0 4MM STP J
220-0011

220-0641-41

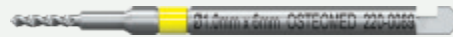

220-0089 1.0mm Pilot Drill, 6mm Stop, J-Latch

1.0 JL 6 STP
220-0089

220-0641-47



220-0318 0.9mm Pilot Drill, 3mm Stop, J-Latch

9 J 3STP
220-0318

220-0641-52



220-0319 0.9mm Pilot Drill, 4mm Stop, J-Latch

9 J 4STP
220-0319

220-0641-53

1.2mm Drivers



114-1215 1.2mm Driver Stem, Short, Hex Shank

1.2STEM S HEX
114-1215

220-0641-55



114-1233 1.2mm Driver Stem, Long, Hex Shank

1.2STEM L HEX
114-1233

220-0641-57



220-0081 1.2mm Screwdriver Shaft, Long, Manual

1.2 STEM EXT
220-0081

220-0641-46



PLATING MODULE

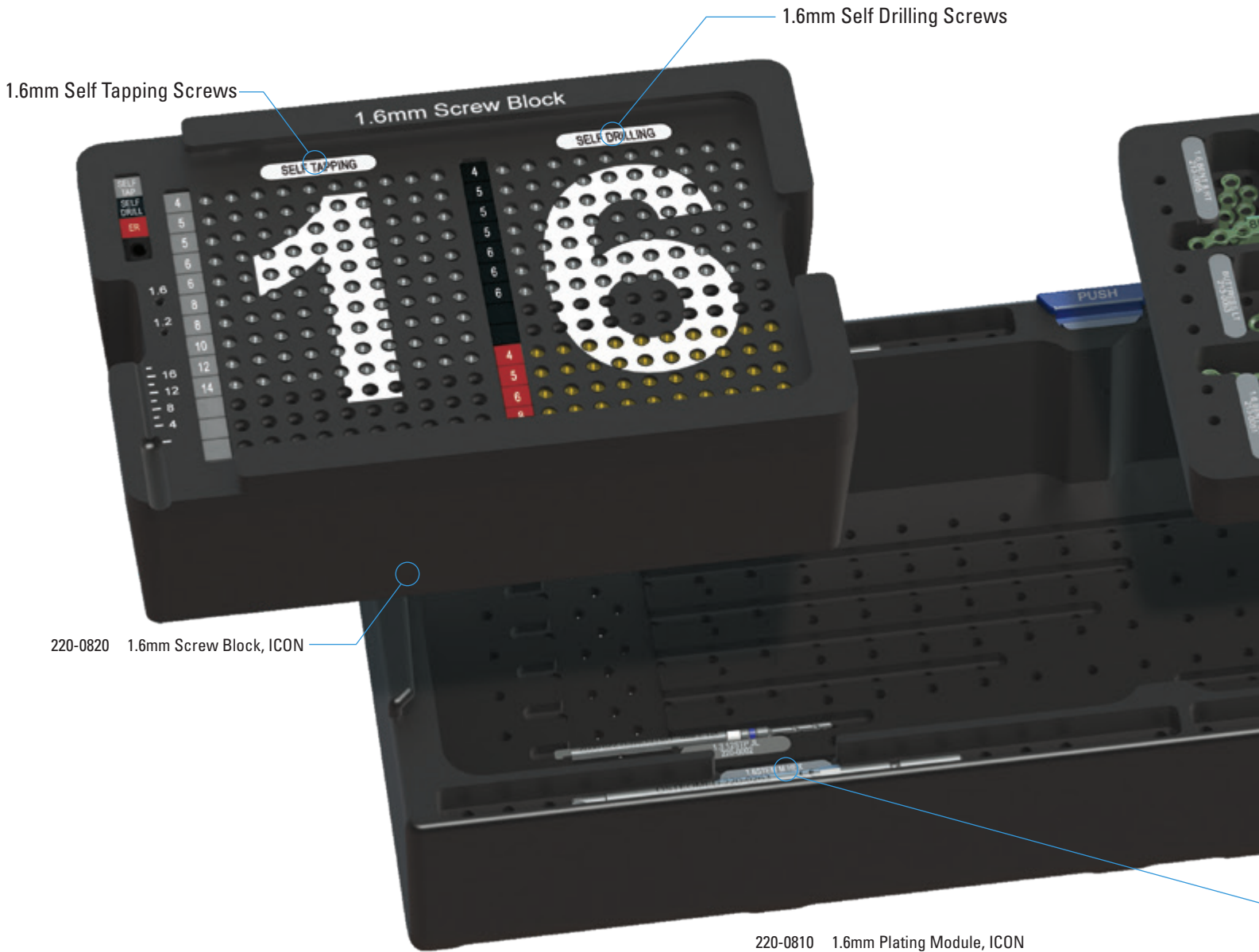

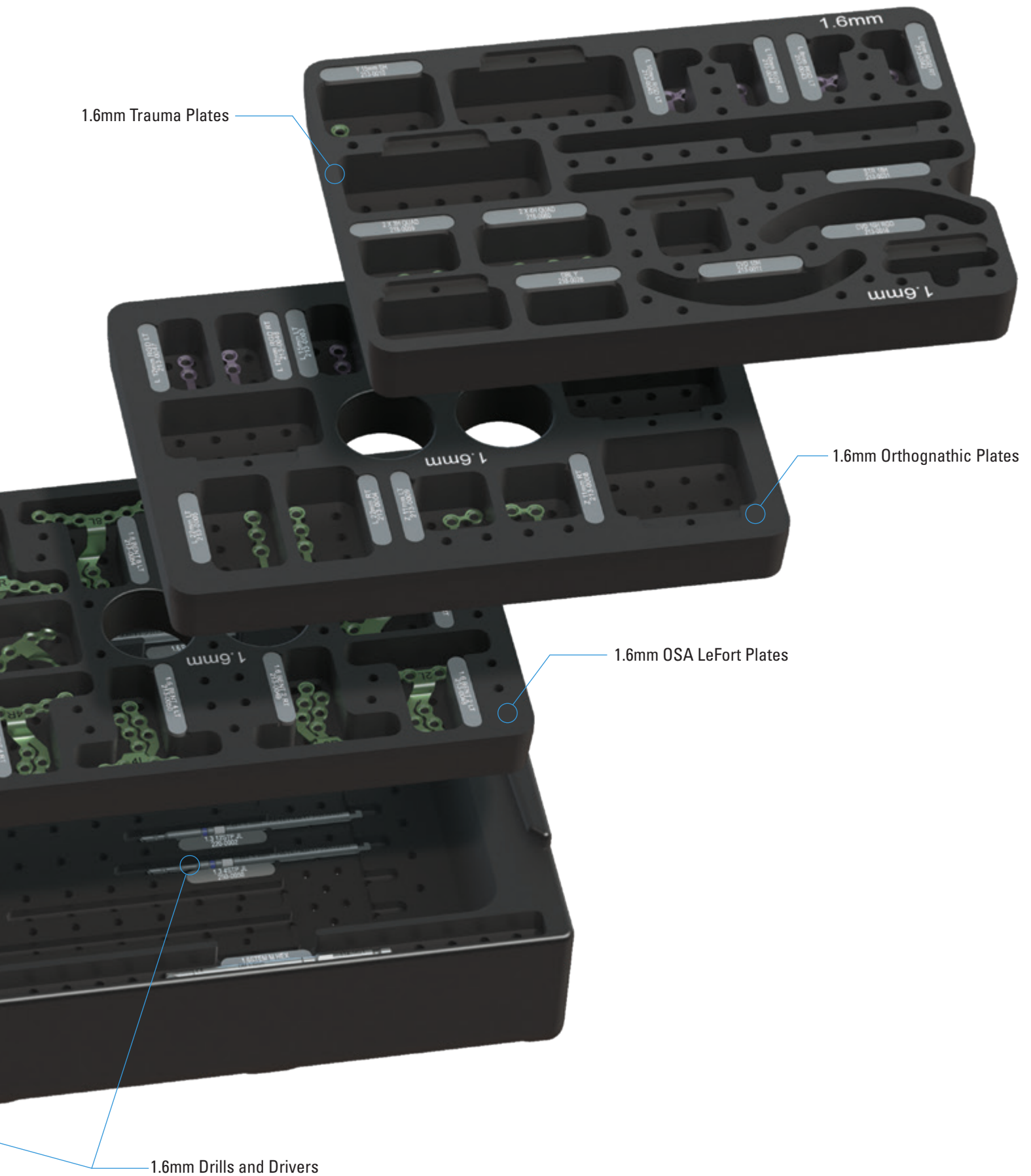

1.6mm Trauma Plates







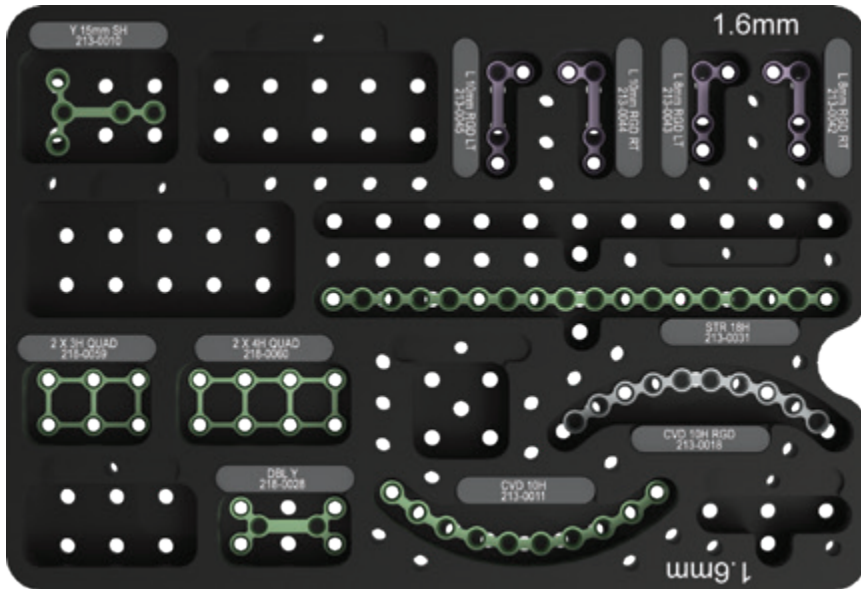

1.6mm Orthognathic Plates

1.6mm OSA LeFort Plates

1.6mm Drills and Drivers

1.6mm TRAUMA PLATES



	213-0010 15mm 5 Hole "Y" Plate	Y 15mm 5H 213-0010	220-0644-11 Plate Tag - Y 15mm 5H
	213-0011 10 Hole Curved Plate	CVD 10H 213-0011	220-0644-12 Plate Tag - CVD 10H
	213-0018 1.6mm Rigid Curved Plate, 10 Hole	CVD 10H RGD 213-0018	220-0644-17 Plate Tag - CVD 10H RGD
	213-0031 1.6mm, Straight Plate, 18 Hole	STR 18H 213-0031	220-0644-20 Plate Tag - STR 18H
	213-0042 Right "L" Plate, 8mm, Rigid	L 8mm RGD RT 213-0042	220-0644-23 Plate Tag - L 8mm RGD RT
	213-0043 Left "L" Plate, 8mm, Rigid	L 8mm RGD LT 213-0043	220-0644-24 Plate Tag - L 8mm RGD LT
	213-0044 Right "L" Plate, 10mm, Rigid	L 10mm RGD RT 213-0044	220-0644-25 Plate Tag - L 10mm RGD RT
	213-0045 Left "L" Plate, 10mm, Rigid	L 10mm RGD LT 213-0045	220-0644-26 Plate Tag - L 10mm RGD LT

1.6mm TRAUMA PLATES

	218-0028 Double "Y" Plate	DBL Y 218-0028	220-0644-55 Plate Tag - DBL Y
	218-0059 2 x 3 Hole Quad Plate	2 X 3H QUAD 218-0059	220-0644-56 Plate Tag - 2 X 3H QUAD
	218-0060 2 x 4 Hole Quad Plate	2 X 4H QUAD 218-0060	220-0644-57 Plate Tag - 2 X 4H QUAD

1.6mm ORTHOGNATHIC PLATES

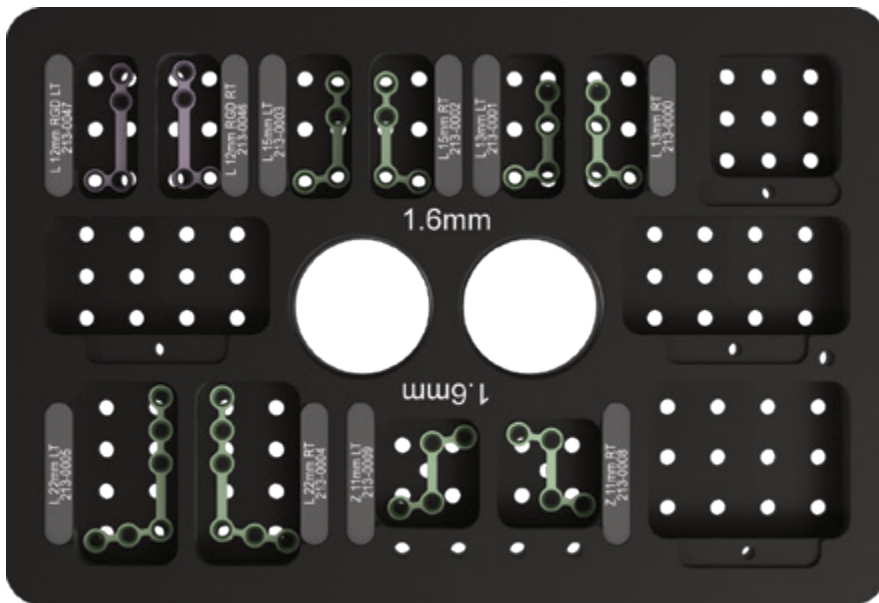

	213-0000 13mm Right "L" Plate	L 13mm RT 213-0000	220-0644-01 Plate Tag - L 13mm RT
	213-0001 13mm Left "L" Plate	L 13mm LT 213-0001	220-0644-02 Plate Tag - L 13mm LT
	213-0002 15mm Right "L" Plate	L 15mm RT 213-0002	220-0644-03 Plate Tag - L 15mm RT
	213-0003 15mm Left "L" Plate	L 15mm LT 213-0003	220-0644-04 Plate Tag - L 15mm LT

1.6mm ORTHOGNATHIC PLATES



213-0004
22mm Right "L" Plate



220-0644-05
Plate Tag - L 22mm RT



213-0005
22mm Left "L" Plate



220-0644-06
Plate Tag - L 22mm LT



213-0008
11mm Right ZED Plate



220-0644-09
Plate Tag - Z 11mm RT



213-0009
11mm Left ZED Plate



220-0644-10
Plate Tag - Z 11mm LT



213-0046
Right "L" Plate, 12mm, Rigid



220-0644-27
Plate Tag - L 12mm RGD RT



213-0047
Left "L" Plate, 12mm, Rigid



220-0644-28
Plate Tag - L 12mm RGD LT

1.6mm OSA LEFORT PLATES

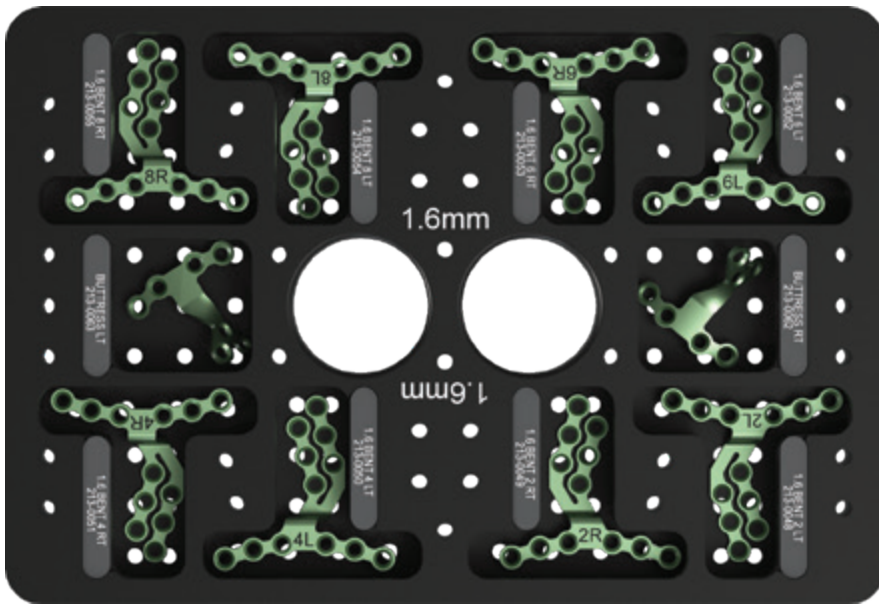

213-0048
1.6mm Pre-bent Plate,
2mm step, Left

1.6 BENT 2 LT
213-0048

220-0644-29
Plate Tag - 1.6 BENT 2 LT



213-0049
1.6mm Pre-bent Plate,
2mm step, Right

1.6 BENT 2 RT
213-0049

220-0644-30
Plate Tag - 1.6 BENT 2 RT



213-0050
1.6mm Pre-bent Plate,
4mm step, Left

1.6 BENT 4 LT
213-0050

220-0644-31
Plate Tag - 1.6 BENT 4 LT



213-0051
1.6mm Pre-bent Plate,
4mm step, Right

1.6 BENT 4 RT
213-0051

220-0644-32
Plate Tag - 1.6 BENT 4 RT

1.6mm OSA LEFORT PLATES

	<p>213-0052 1.6mm Pre-bent Plate, 6mm step, Left</p>	<p>1.6 BENT 6 LT 213-0052</p>	<p>220-0644-33 Plate Tag - 1.6 BENT 6 LT</p>
---	--	-----------------------------------	--

	<p>213-0053 1.6mm Pre-bent Plate, 6mm step, Right</p>	<p>1.6 BENT 6 RT 213-0053</p>	<p>220-0644-34 Plate Tag - 1.6 BENT 6 RT</p>
---	---	-----------------------------------	--

	<p>213-0054 1.6mm Pre-bent Plate, 8mm step, Left</p>	<p>1.6 BENT 8 LT 213-0054</p>	<p>220-0644-35 Plate Tag - 1.6 BENT 8 LT</p>
---	--	-----------------------------------	--

	<p>213-0055 1.6mm Pre-bent Plate, 8mm step, Right</p>	<p>1.6 BENT 8 RT 213-0055</p>	<p>220-0644-36 Plate Tag - 1.6 BENT 8 RT</p>
--	---	-----------------------------------	--

	<p>213-0062 Buttress Plate Right</p>	<p>BUTTRESS RT 213-0062</p>	<p>220-0644-41 Plate Tag - BUTTRESS RT</p>
---	--	---------------------------------	--

	<p>213-0063 Buttress Plate Left</p>	<p>BUTTRESS LT 213-0063</p>	<p>220-0644-42 Plate Tag - BUTTRESS LT</p>
---	---	---------------------------------	--

ADDITIONAL 1.6mm PLATES

	<p>213-0006 9mm Right ZED Plate</p>	<p>Z 9mm RT 213-0006</p>	<p>220-0644-07 Plate Tag - Z 9mm RT</p>
---	---	------------------------------	---

	<p>213-0007 9mm Left ZED Plate</p>	<p>Z 9mm LT 213-0007</p>	<p>220-0644-08 Plate Tag - Z 9mm LT</p>
---	--	------------------------------	---

	<p>213-0013 4 Hole "I" Plate</p>	<p>I 4H 213-0013</p>	<p>220-0644-13 Plate Tag - I 4H</p>
---	--------------------------------------	--------------------------	---

ADDITIONAL 1.6mm PLATES



213-0014
18mm 4 Hole Straight Plate

STR 4H 18mm
213-0014

220-0644-14
Plate Tag - STR 4H 18mm



213-0016
12 Hole Straight Plate

STR 12H
213-0016

220-0644-15
Plate Tag - STR 12H

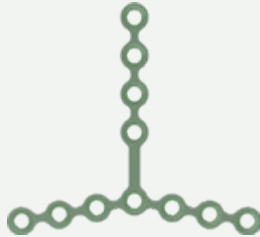

213-0017
11 Hole Extended "Y" Plate

EXT Y 11H
213-0017

220-0644-16
Plate Tag - EXT Y 11H



213-0019
1.6mm Rigid Straight Plate,
10 Hole

STR 10H RGD
213-0019

220-0644-18
Plate Tag - STR 10H RGD



213-0028
1.6mm, L-Plate, Left, 8 Hole

1.6 8H LT
213-0028

220-0644-19
Plate Tag - 1.6 8H LT



213-0040
Right "L" Plate, 6mm, Rigid

L 6mm RGD RT
213-0040

220-0644-21
Plate Tag - L 6mm RGD RT



213-0041
Left "L" Plate, 6mm, Rigid

L 6mm RGD LT
213-0041

220-0644-22
Plate Tag - L 6mm RGD LT



213-0056
1.6mm Pre-bent Plate,
10mm step, Left

1.6 BENT 10 LT
213-0056

220-0644-37
Plate Tag - 1.6 BENT 10 LT



213-0057
1.6mm Pre-bent Plate,
10mm step, Right

1.6 BENT 10 RT
213-0057

220-0644-38
Plate Tag - 1.6 BENT 10 RT

ADDITIONAL 1.6mm PLATES



213-0058
1.6mm Pre-bent Plate,
12mm step, Left

1.6 BENT 12 LT
213-0058

220-0644-39
Plate Tag - 1.6 BENT 12 LT



213-0059
1.6mm Pre-bent Plate,
12mm step, Right

1.6 BENT 12 RT
213-0059

220-0644-40
Plate Tag - 1.6 BENT 12 RT



213-0064
1.6mm Buttress Plate,
Left, Modified

BUTTR MOD LT
213-0064

220-0644-43
Plate Tag - BUTTR MOD LT



213-0065
1.6mm Buttress Plate,
Right, Modified

BUTTR MOD RT
213-0065

220-0644-44
Plate Tag - BUTTR MOD RT



213-0066
1.6mm Modified L Plate
6 Hole Right

L 6H MOD RT
213-0066

220-0644-45
Plate Tag - L 6H MOD RT



213-0067
1.6mm Modified L Plate
6 Hole Left

L 6H MOD LT
213-0067

220-0644-46
Plate Tag - L 6H MOD LT



213-0082
1.6mm Pre-bent Plate,
5mm step, Left

1.6 BENT 5 LT
213-0082

220-0644-47
Plate Tag - 1.6 BENT 5 LT



213-0083
1.6mm Pre-bent Plate,
5mm step, Right

1.6 BENT 5 RT
213-0083

220-0644-48
Plate Tag - 1.6 BENT 5 RT

ADDITIONAL 1.6mm PLATES



213-0120
Right "L" Plate, 8mm, Rigid

L 8mm RGD RT
213-0120

220-0644-49
Plate Tag - L 8mm RGD RT



213-0121
Left "L" Plate, 8mm, Rigid

L 8mm RGD LT
213-0121

220-0644-50
Plate Tag - L 8mm RGD LT



213-0200
1.6mm Modified LeFort Plate,
Left, 2mm

MOD LF 2mm LT
213-0200

220-0644-51
Plate Tag - MOD LF 2mm LT



213-0201
1.6mm Modified LeFort Plate,
Right, 2mm

MOD LF 2mm RT
213-0201

220-0644-52
Plate Tag - MOD LF 2mm RT



213-0202
1.6mm Modified LeFort Plate,
Left, 3mm

MOD LF 3mm LT
213-0202

220-0644-53
Plate Tag - MOD LF 3mm LT



213-0203
1.6mm Modified LeFort Plate,
Right, 3mm

MOD LF 3mm RT
213-0203

220-0644-54
Plate Tag - MOD LF 3mm RT

ADDITIONAL 1.6mm ORBITAL PLATES

*1.6mm Orbital Floor Plates are located in the Auxiliary Tray

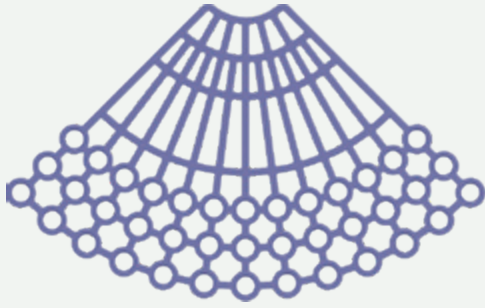

213-1661
1.6mm Orbital Floor Plate,
Fan, .2mm Thick

ORB FAN_2
213-1661

220-0644-81
Plate Tag - ORB FAN .2

213-1663
* 1.6mm Orbital Floor Plate,
Fan, .3mm Thick

ORB FAN_3
213-1663

220-0644-83
Plate Tag - ORB FAN .3

213-1665
1.6mm Orbital Floor Plate,
Fan, .4mm Thick

ORB FAN_4
213-1665

220-0644-84
Plate Tag - ORB FAN .4

213-1667
1.6mm Orbital Floor Plate,
Fan, .5mm Thick

ORB FAN_5
213-1667

220-0644-85
Plate Tag - ORB FAN .5

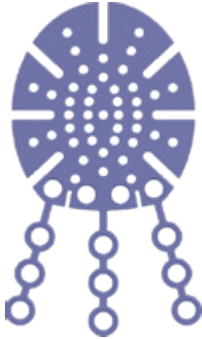

213-1671
1.6mm Orbital Floor Plate,
Pick, .2mm Thick

ORB PICK_2
213-1671

220-0644-86
Plate Tag - ORB PICK .2

213-1673
* 1.6mm Orbital Floor Plate,
Pick, .3mm Thick

ORB PICK_3
213-1673

220-0644-88
Plate Tag - ORB PICK .3

213-1675
1.6mm Orbital Floor Plate,
Pick, .4mm Thick

ORB PICK_4
213-1675

220-0644-89
Plate Tag - ORB PICK .4

213-1677
1.6mm Orbital Floor Plate,
Pick, .5mm Thick

ORB PICK_5
213-1677

220-0644-90
Plate Tag - ORB PICK .5



213-1681
1.6mm Orbital Floor Plate,
Preformed, Left, .2mm Thick

ORB PREF L_2
213-1681

220-0644-91
Plate Tag - ORB PREF L.2

213-1683
1.6mm Orbital Floor Plate,
Preformed, Left, .3mm Thick

ORB PREF L_3
213-1683

220-0644-93
Plate Tag - ORB PREF L.3

213-1685
1.6mm Orbital Floor Plate,
Preformed, Left, .4mm Thick

ORB PREF L_4
213-1685

220-0644-94
Plate Tag - ORB PREF L.4

213-1687
1.6mm Orbital Floor Plate,
Preformed, Left, .5mm Thick

ORB PREF L_5
213-1687

220-0644-95
Plate Tag - ORB PREF L.5



213-1691
1.6mm Orbital Floor Plate,
Preformed, Right, .2mm Thick

ORB PREF R_2
213-1691

220-0644-96
Plate Tag - ORB PREF R.2

213-1693
1.6mm Orbital Floor Plate,
Preformed, Right, .3mm Thick

ORB PREF R_3
213-1693

220-0644-98
Plate Tag - ORB PREF R.3

213-1695
1.6mm Orbital Floor Plate,
Preformed, Right, .4mm Thick

ORB PREF R_4
213-1695

220-0644-99
Plate Tag - ORB PREF R.4

213-1697
1.6mm Orbital Floor Plate,
Preformed, Right, .5mm Thick

ORB PREF R_5
213-1697

220-0644-100
Plate Tag - ORB PREF R.5

1.6mm SCREWS

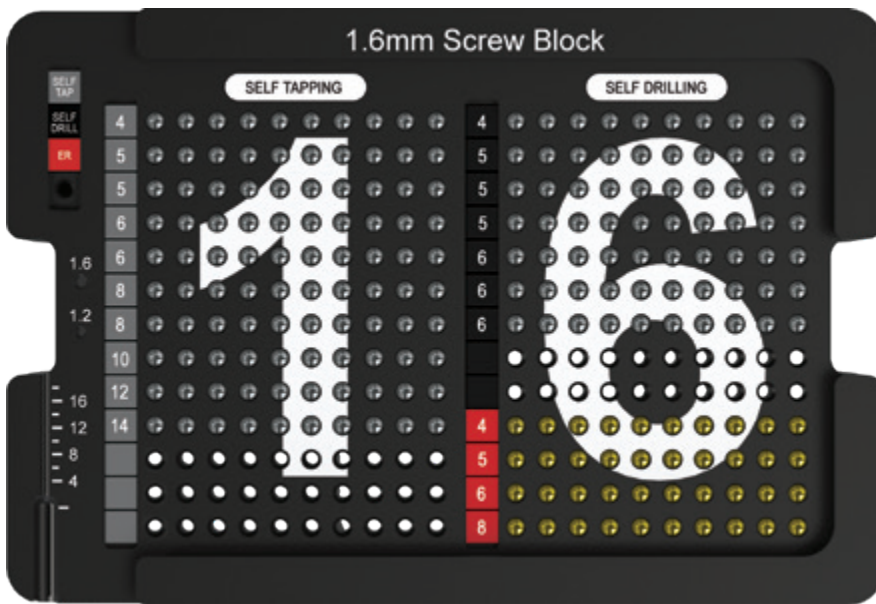

220-0820 1.6mm Screw Block, ICON

SELF TAPPING

220-0641-36 SELF TAPPING White ID Tag, SELF TAPPING

SELF DRILLING

220-0641-35 SELF DRILLING White ID Tag, SELF DRILLING

1.6mm Self Tapping Screws



P/N	Description
208-1603	1.6mm x 3mm Standard Screw
208-1604	1.6mm x 4mm Standard Screw
208-1605	1.6mm x 5mm Standard Screw
208-1606	1.6mm x 6mm Standard Screw
208-1608	1.6mm x 8mm Standard Screw
208-1610	1.6mm x 10mm Standard Screw
208-1612	1.6mm x 12mm Standard Screw
208-1614	1.6mm x 14mm Standard Screw

1.6mm Self Tapping Screw Tags



220-0614-99 TAG, SELF TAP

P/N	Description
220-0614-03	3
220-0614-04	4
220-0614-05	5
220-0614-06	6
220-0614-08	8
220-0614-10	10
220-0614-12	12
220-0614-14	14

1.6mm Self Drilling Screws



P/N	Description
211-1603	1.6mm x 3mm AUTO-DRIVE® Screw
211-1604	1.6mm x 4mm AUTO-DRIVE® Screw
211-1605	1.6mm x 5mm AUTO-DRIVE® Screw
211-1606	1.6mm x 6mm AUTO-DRIVE® Screw
211-1608	1.6mm x 8mm AUTO-DRIVE® Screw

1.6mm Self Drilling Screw Tags



220-0616-99 TAG, SELF DRILL

P/N	Description
220-0616-03	3
220-0616-04	4
220-0616-05	5
220-0616-06	6
220-0616-08	8

1.6mm Emergency Screws



P/N	Description
208-1903	1.9mm x 3mm Safety Screw
208-1904	1.9mm x 4mm Safety Screw
208-1905	1.9mm x 5mm Safety Screw
208-1906	1.9mm x 6mm Safety Screw
208-1908	1.9mm x 8mm Safety Screw
208-1910	1.9mm x 10mm Safety Screw
208-1912	1.9mm x 12mm Safety Screw
208-1914	1.9mm x 14mm Safety Screw

1.6mm Emergency Screw Tags



220-0615-99 TAG, ER

P/N	Description
220-0615-03	3
220-0615-04	4
220-0615-05	5
220-0615-06	6
220-0615-08	8
220-0615-10	10
220-0615-12	12
220-0615-14	14

1.6mm INSTRUMENTS

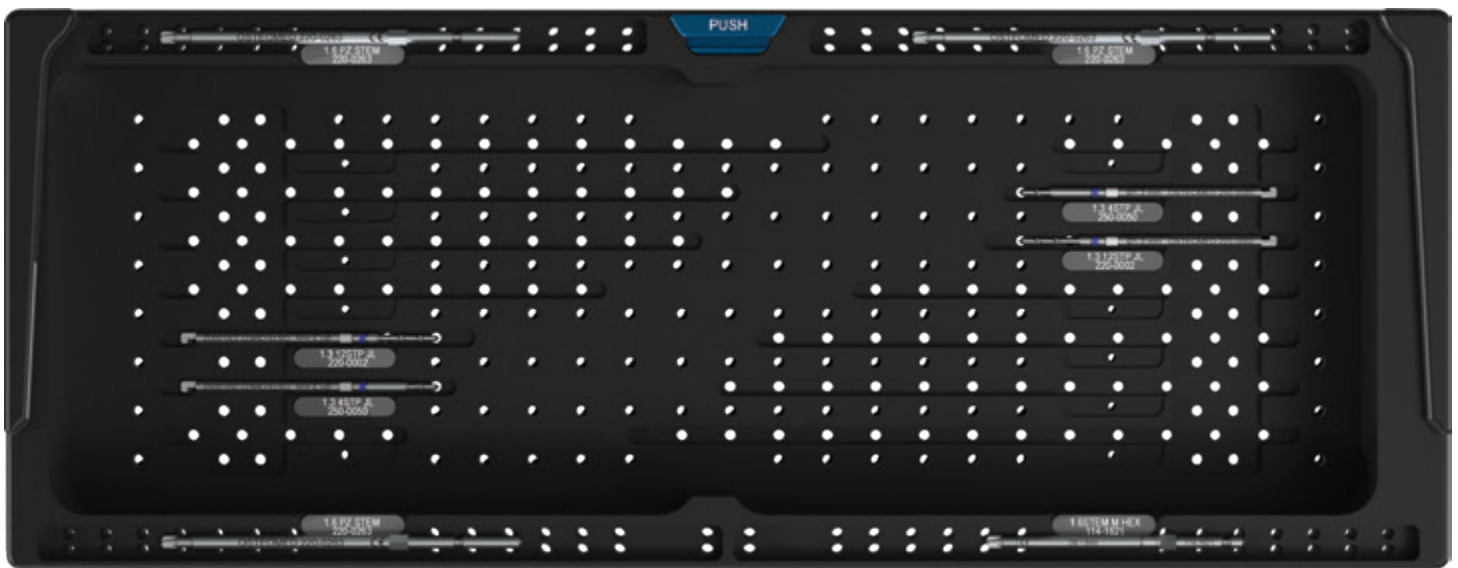

1.6mm Drills

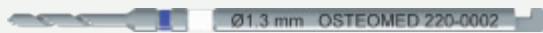

220-0002 1.3mm Pilot Drill, J-Latch, 12mm

1.3 12STP JL
220-0002

220-0644-58



250-0050 1.3mm Pilot Drill, 6mm Stop, J-Latch

1.3 6STP JL
250-0050

220-0644-80

1.6mm Drivers



114-1621 1.6mm Driver Stem, Medium, Hex Shank

1.6STEM M HEX
114-1621

220-0644-78



220-0263 Profile Zero, 1.6mm Screwdriver Shaft, Manual

1.6 PZ STEM
220-0263

220-0644-67

1.6mm ADDITIONAL INSTRUMENTS

1.6mm Drills

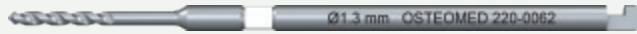

1.3 16STP JL
220-0062

220-0062 1.3mm Pilot Drill, J-Latch, 16mm

220-0644-59



1.3 4STP JL
220-0091

220-0091 1.3mm Pilot Drill, 4mm Stop, J-Latch

220-0644-64



1.3 EXT JL
220-0209

220-0209 1.3mm Pilot Drill, J-Latch, Extended Length

220-0644-66



1.1 4STP JL
222-0004

222-0004 1.1mm Pilot Drill, 4mm Stop, J-Latch

220-0644-72



1.1 6STP JL
222-0006

222-0006 1.1mm Pilot Drill, 6mm Stop, J-Latch

220-0644-74

1.6mm Drivers



1.6STEM S HEX
114-1615

114-1615 1.6mm Driver Stem, Short, Hex Shank

220-0644-77



1.6STEM L HEX
114-1633

114-1633 1.6mm Driver Stem, Long, Hex Shank

220-0644-79



PLATING MODULE

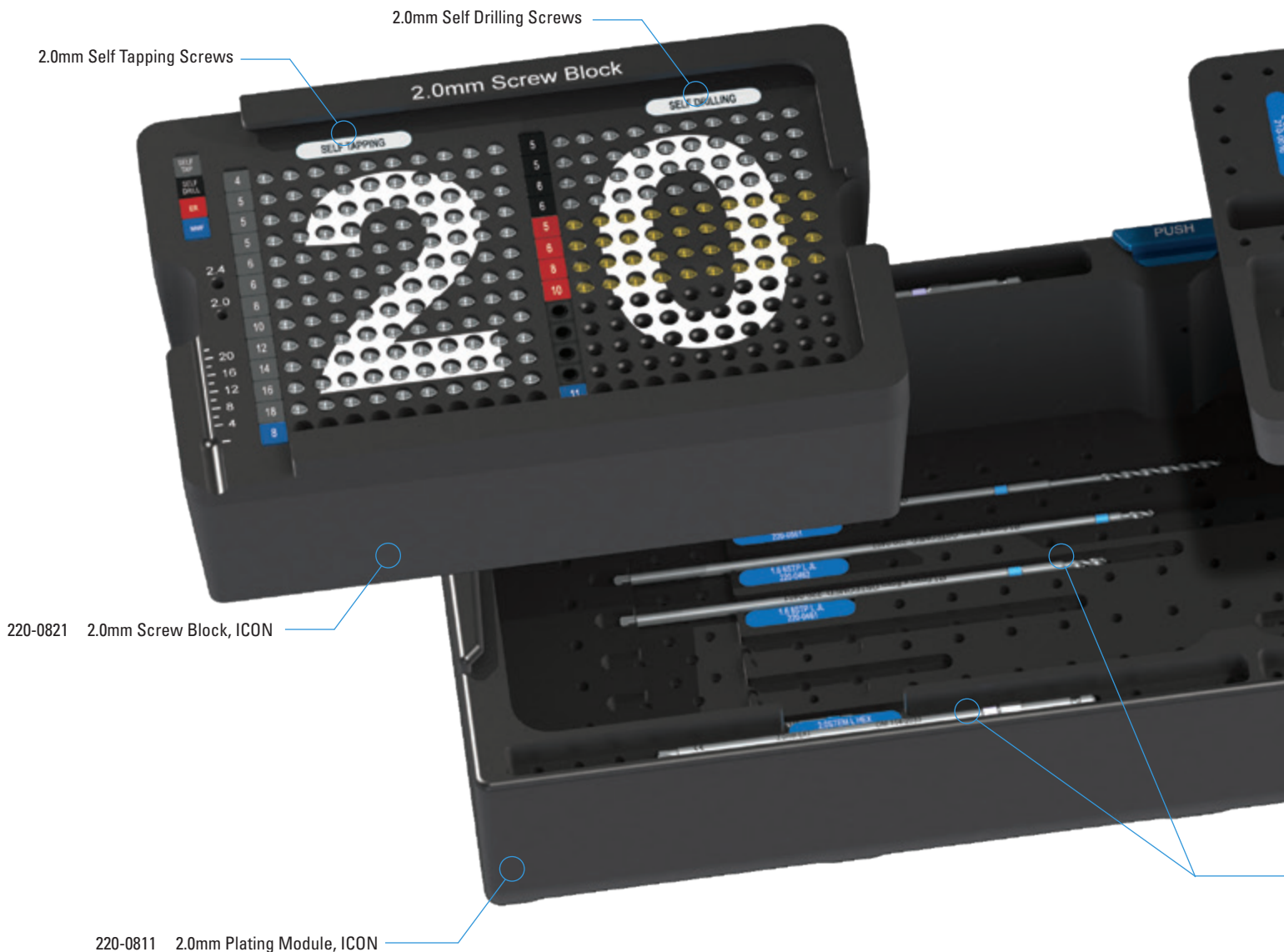

2.0mm Self Tapping Screws

2.0mm Self Drilling Screws

220-0821 2.0mm Screw Block, ICON

220-0811 2.0mm Plating Module, ICON



2.0mm Drills and Drivers

2.0mm TRAUMA TRAY

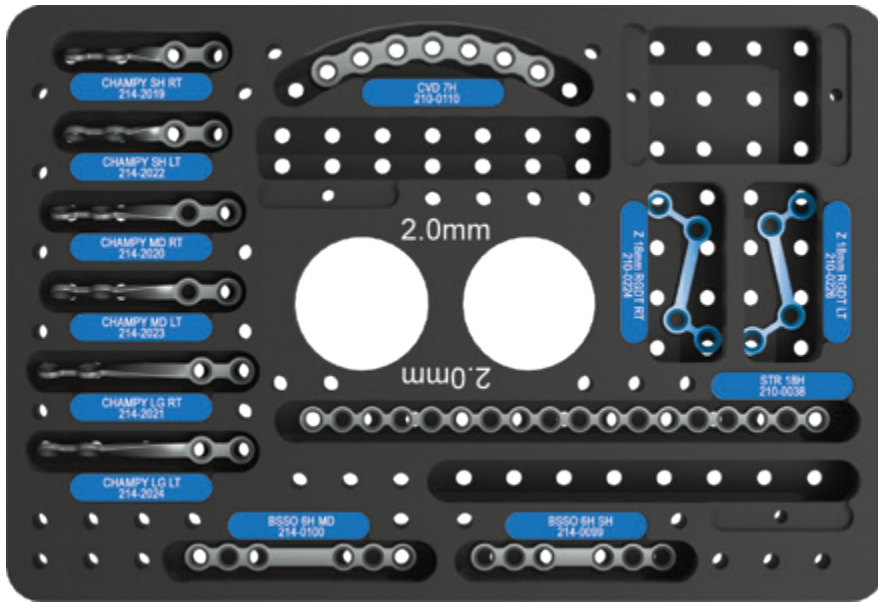

210-0038
18 Hole Straight Plate

STR 18H
210-0038

220-0640-17
Plate Tag - STR 18H



210-0110
7 Hole Curved Plate

CVD 7H
210-0110

220-0640-36
Plate Tag - CVD 7H



210-0224
18mm Right ZED Rigid Plate

Z 18mm RGD RT
210-0224

220-0640-47
Plate Tag - Z 18mm RGD RT



210-0226
18mm Left ZED Rigid Plate

Z 18mm RGD LT
210-0226

220-0640-48
Plate Tag - Z 18mm RGD LT



214-0099
Short 6 Hole BSSO Plate

BSSO 6H SH
214-0099

220-0640-117
Plate Tag - BSSO 6H SH



214-0100
Medium 6 Hole BSSO Plate

BSSO 6H MD
214-0100

220-0640-118
Plate Tag - BSSO 6H MD



214-2019
2.0mm Champy Plate,
Short, Right

CHAMPY SH RT
214-2019

220-0640-125
Plate Tag - CHAMPY SH RT





214-2020
2.0mm Champy Plate,
Medium, Right

CHAMPY MD RT
214-2020

220-0640-126
Plate Tag - CHAMPY MD RT

2.0mm TRAUMA TRAY

	214-2021 2.0mm Champy Plate, Long, Right	CHAMPY LG RT 214-2021	220-0640-127 Plate Tag - CHAMPY LG RT
	214-2022 2.0mm Champy Plate, Short, Left	CHAMPY SH LT 214-2022	220-0640-128 Plate Tag - CHAMPY SH LT
	214-2023 2.0mm Champy Plate, Medium, Left	CHAMPY MD LT 214-2023	220-0640-129 Plate Tag - CHAMPY MD LT
	214-2024 2.0mm Champy Plate, Long, Left	CHAMPY LG LT 214-2024	220-0640-130 Plate Tag - CHAMPY LG LT

2.0mm ORTHOGNATHIC TRAY

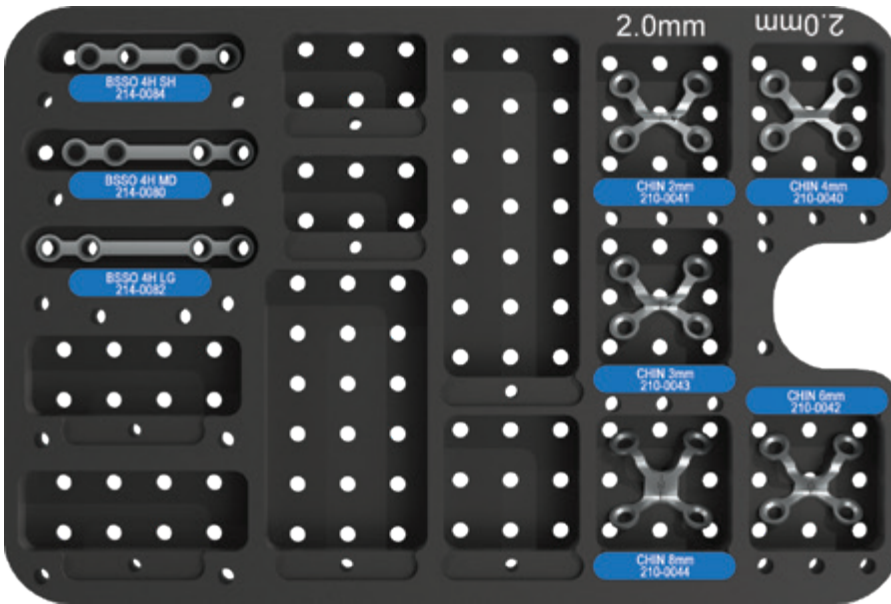

	210-0040 4mm Chin Plate	CHIN 4mm 210-0040	220-0640-18 Plate Tag - CHIN 4mm
	210-0041 2mm Chin Plate	CHIN 2mm 210-0041	220-0640-19 Plate Tag - CHIN 2mm
	210-0042 6mm Chin Plate	CHIN 6mm 210-0042	220-0640-20 Plate Tag - CHIN 6mm

2.0mm ORTHOGNATHIC TRAY

	210-0043 3mm Chin Plate	CHIN 3mm 210-0043	220-0640-21 Plate Tag - CHIN 3mm
	210-0044 8mm Chin Plate	CHIN 8mm 210-0044	220-0640-22 Plate Tag - CHIN 8mm
	214-0080 Medium 4 Hole BSSO Plate	BSSO 4H MD 214-0080	220-0640-111 Plate Tag - BSSO 4H MD
	214-0082 Long 4 Hole BSSO Plate	BSSO 4H LG 214-0082	220-0640-112 Plate Tag - BSSO 4H LG
	214-0084 Short 4 Hole BSSO Plate	BSSO 4H SH 214-0084	220-0640-114 Plate Tag - BSSO 4H SH

2.0mm OSA LEFORT TRAY

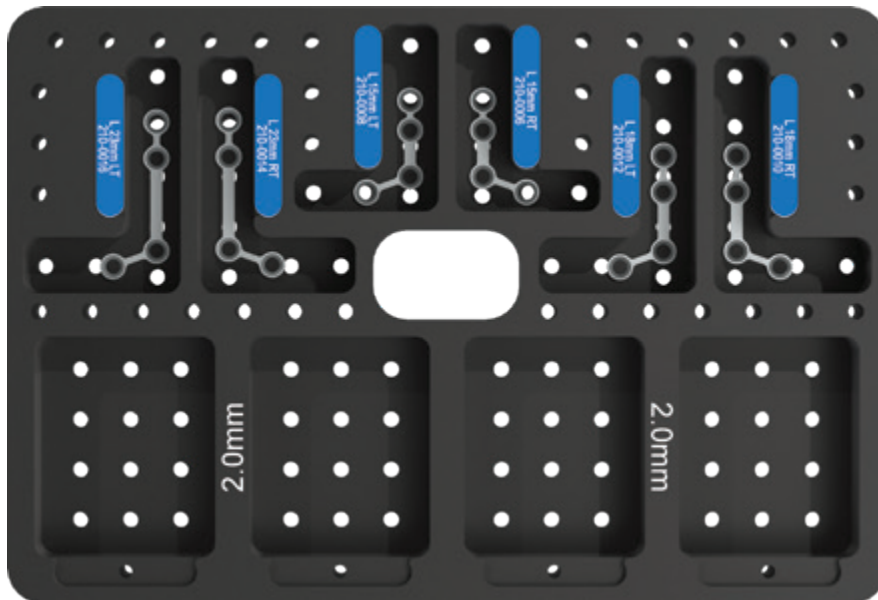

	210-0006 15mm Right "L" Plate	L 15mm RT 210-0006	220-0640-01 Plate Tag - L 15mm RT
	210-0008 15mm Left "L" Plate	L 15mm LT 210-0008	220-0640-02 Plate Tag - L 15mm LT

2.0mm OSA LEFORT TRAY



210-0010
18mm Right "L" Plate

L 18mm RT
210-0010

220-0640-03
Plate Tag - L 18mm RT



210-0012
18mm Left "L" Plate

L 18mm LT
210-0012

220-0640-04
Plate Tag - L 18mm LT



210-0014
23mm Right "L" Plate

L 23mm RT
210-0014

220-0640-05
Plate Tag - L 23mm RT



210-0016
23mm Left "L" Plate

L 23mm LT
210-0016

220-0640-06
Plate Tag - L 23mm LT

ADDITIONAL 2.0mm PLATES



210-0081
Extended Right "L" Plate

EXT L RT
210-0081

220-0640-30
Plate Tag - EXT L RT



210-0082
Extended Left "L" Plate

EXT L LT
210-0082

220-0640-31
Plate Tag - EXT L LT

ADDITIONAL 2.0mm PLATES



210-0018
26mm "Y" Plate

Y 26mm
210-0018

220-0640-07
Plate Tag - Y 26mm



210-0020
15mm Right ZED Plate

Z 15mm RT
210-0020

220-0640-08
Plate Tag - Z 15mm RT



210-0022
15mm Left ZED Plate

Z 15mm LT
210-0022

220-0640-09
Plate Tag - Z 15mm LT



210-0024
18mm Right ZED Plate

Z 18mm RT
210-0024

220-0640-10
Plate Tag - Z 18mm RT



210-0026
18mm Left ZED Plate

Z 18mm LT
210-0026

220-0640-11
Plate Tag - Z 18mm LT



210-0030
24mm 4 Hole Straight Plate

STR 4H 24mm
210-0030

220-0640-12
Plate Tag - STR 4H 24mm



210-0032
10 Hole Straight Plate

STR 10H
210-0032

220-0640-13
Plate Tag - STR 10H



210-0034
16 Hole Straight Plate

STR 16H
210-0034

220-0640-14
Plate Tag - STR 16H



210-0035
16mm "I" Plate

I 16mm
210-0035

220-0640-15
Plate Tag - I 16mm













210-0036
22mm "T" Plate











T 22mm
210-0036

220-0640-16
Plate Tag - T 22mm

ADDITIONAL 2.0mm PLATES

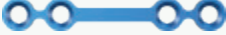
	210-0046 10mm Chin Plate	CHIN 10mm 210-0046	220-0640-23 Plate Tag - CHIN 10mm
	210-0048 12mm Chin Plate	CHIN 12mm 210-0048	220-0640-24 Plate Tag - CHIN 12mm
	210-0052 7mm "X" Plate	X 7mm 210-0052	220-0640-26 Plate Tag - X 7mm
	210-0062 2.0mm, 5mm Chin Plate	2.0 CHIN 5mm 210-0062	220-0640-27 Plate Tag - 2.0 CHIN 5mm
	210-0063 2.0mm, 7mm Chin Plate	2.0 CHIN 7mm 210-0063	220-0640-28 Plate Tag - CHIN 7mm
	210-0080 Extended "Y" Plate	EXT Y LONG 210-0080	220-0640-29 Plate Tag - EXT Y LONG
	210-0206 15mm Right "L" Rigid Plate	L 15mm RGD RT 210-0206	220-0640-38 Plate Tag - L 15mm RGD RT
	210-0208 15mm Left "L" Rigid Plate	L 15mm RGD LT 210-0208	220-0640-39 Plate Tag - L 15mm RGD LT
	210-0210 18mm Right "L" Rigid Plate	L 18mm RGD RT 210-0210	220-0640-40 Plate Tag - L 18mm RGD RT
	210-0212 18mm Left "L" Rigid Plate	L 18mm RGD LT 210-0212	220-0640-41 Plate Tag - L 18mm RGD LT

ADDITIONAL 2.0mm PLATES

	210-0214 23mm Right "L" Rigid Plate	L 23mm RGD RT 210-0214	220-0640-42 Plate Tag - L 23mm RGD RT
	210-0216 23mm Left "L" Rigid Plate	L 23mm RGD LT 210-0216	220-0640-43 Plate Tag - L 23mm RGD LT
	210-0218 26mm "Y" Rigid Plate	Y 26mm RGD 210-0218	220-0640-44 Plate Tag - Y 26mm RGD
	210-0220 15mm Right ZED Rigid Plate	Z 15mm RGD RT 210-0220	220-0640-45 Plate Tag - Z 15mm RGD RT
	210-0222 15mm Left ZED Rigid Plate	Z 15mm RGD LT 210-0222	220-0640-46 Plate Tag - Z 15mm RGD LT
	210-0230 24mm 4 Hole Straight Rigid Plate	STR 4H 24mm 210-0230	220-0640-49 Plate Tag - STR 4H 24mm
	210-0231 29mm 4 Hole Straight Rigid Plate	STR 4H 29mm 210-0231	220-0640-50 Plate Tag - STR 4H 29mm
	210-0232 10 Hole Straight Rigid Plate	STR 10H RGD 210-0232	220-0640-51 Plate Tag - STR 10H RGD
	210-0235 16mm "I" Rigid Plate	I 16mm RGD 210-0235	220-0640-52 Plate Tag - I 16mm RGD
	210-0236 Y Rigid Plate	Y RGD 210-0236	220-0640-53 Plate Tag - Y RGD

ADDITIONAL 2.0mm PLATES



210-0239
Double "Y" Rigid Plate

DBL Y RGD
210-0239

220-0640-54
Plate Tag - DBL Y RGD



210-0250
2.0mm Right L Plate,
15mm, Rigid

L 15mm RGD RT
210-0250

220-0640-119
Plate Tag - L 15mm RGD RT



210-0251
2.0mm Left L Plate,
15mm, Rigid

L 15mm RGD LT
210-0251

220-0640-120
Plate Tag - L 15mm RGD LT



210-0252
2.0mm Right L Plate,
18mm, Rigid

L 18mm RGD RT
210-0252

220-0640-121
Plate Tag - L 18mm RGD RT



210-0253
2.0mm Left L Plate,
18mm, Rigid

L 18mm RGD LT
210-0253

220-0640-122
Plate Tag - L 18mm RGD LT



210-0254
2.0mm Right L Plate,
23mm, Rigid

L 23mm RGD RT
210-0254

220-0640-123
Plate Tag - L 23mm RGD RT



210-0255
2.0mm Left L Plate,
23mm, Rigid

L 23mm RGD LT
210-0255

220-0640-124
Plate Tag - L 23mm RGD LT



210-1013
12 Hole Straight Plate,
1.0mm Thick

STR 12H 1mm
210-1013

220-0640-74
Plate Tag - STR 12H 1mm



210-1021
Mini, 34 Hole Strip

34H STRIP
210-1021

220-0640-75
Plate Tag - 34H STRIP

ADDITIONAL 2.0mm PLATES



210-1022
Mini, 68 Hole Strip, Rigid

68H STRIP RGD
210-1022

220-0640-76
Plate Tag - 68H STRIP RGD



210-1030
Mini, 4 Hole Straight Plate,
1.0mm

STR 4H 1mm
210-1030

220-0640-79
Plate Tag - STR 4H 1mm



210-1031
Mini, 6 Hole Straight Plate,
1.0mm

STR 6H 1mm
210-1031

220-0640-80
Plate Tag - STR 6H 1mm



210-1032
Mini, 8 Hole Straight Plate,
1.0mm

STR 8H 1mm
210-1032

220-0640-81
Plate Tag - STR 8H 1mm



210-1036
Mini, 16 Hole Straight Plate,
1.0mm

STR 16H 1mm
210-1036

220-0640-82
Plate Tag - STR 16H 1mm



210-1037
2.0mm, 4 Hole Straight Rigid
Plate

STR 4H RGD
210-1037

220-0640-83
Plate Tag - STR 4H RGD



210-1038
2.0mm, 12 Hole Double Row
Rigid Plate

STR 12X2H RGD
210-1038

220-0640-84
Plate Tag - STR 12X2H RGD



210-1039
2.0mm, 10 Hole Double Row
Rigid Plate

STR 10X2 RGD
210-1039

220-0640-85
Plate Tag - STR 10X2 RGD



214-0083
Long 6 Hole BSSO Plate

BSSO 6H LG
214-0083

220-0640-113
Plate Tag - BSSO 6H LG



214-0086
Short TR BSSO Plate

BSSO TR SH
214-0086

220-0640-115
Plate Tag - BSSO TR SH



214-0088
Long TR BSSO Plate

BSSO TR LG
214-0088

220-0640-116
Plate Tag - BSSO TR LG

2.0mm SCREWS

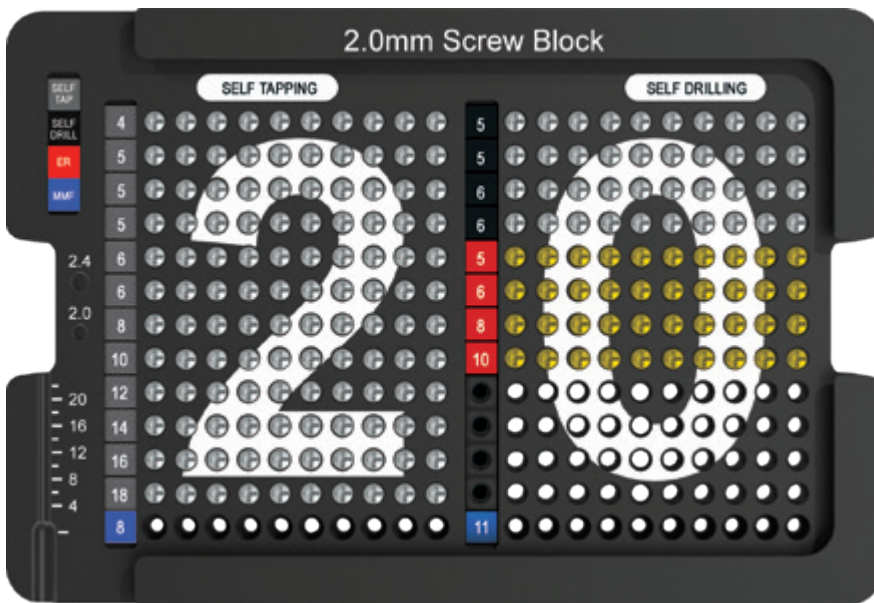

220-0821 2.0mm Screw Block, ICON

SELF TAPPING

220-0641-36 SELF TAPPING White ID Tag, SELF TAPPING

SELF DRILLING

220-0641-35 SELF DRILLING White ID Tag, SELF DRILLING

2.0mm Self Tapping Screws



P/N	Description
234-2004	ICON, 2.0 x 4mm Screw, Self-Tapping
234-2005	ICON, 2.0 x 5mm Screw, Self-Tapping
234-2006	ICON, 2.0 x 6mm Screw, Self-Tapping
234-2008	ICON, 2.0 x 8mm Screw, Self-Tapping
234-2010	ICON, 2.0 x 10mm Screw, Self-Tapping
234-2012	ICON, 2.0 x 12mm Screw, Self-Tapping
234-2014	ICON, 2.0 x 14mm Screw, Self-Tapping
234-2016	ICON, 2.0 x 16mm Screw, Self-Tapping
234-2018	ICON, 2.0 x 18mm Screw, Self-Tapping
234-2020	ICON, 2.0 x 20mm Screw, Self-Tapping
234-2022	ICON, 2.0 x 22mm Screw, Self-Tapping
234-2024	ICON, 2.0 x 24mm Screw, Self-Tapping

2.0mm Self Tapping Screw Tags



220-0614-99 TAG, SELF TAP

P/N	Description
220-0614-04	4
220-0614-05	5
220-0614-06	6
220-0614-08	8
220-0614-10	10
220-0614-12	12
220-0614-14	14
220-0614-16	16
220-0614-18	18
220-0614-20	20
220-0614-22	22
220-0614-24	24

2.0mm Self Drilling Screws



P/N	Description
235-2004	ICON, 2.0 x 4mm Auto-Drive® Screw
235-2005	ICON, 2.0 x 5mm Auto-Drive® Screw
235-2006	ICON, 2.0 x 6mm Auto-Drive® Screw
235-2008	ICON, 2.0 x 8mm Auto-Drive® Screw

2.0mm Self Drilling Screw Tags



220-0616-99 TAG, SELF DRILL

P/N	Description
220-0616-04	4
220-0616-05	5
220-0616-06	6
220-0616-07	8

2.0mm SCREWS

2.3mm Emergency Screws



P/N	Description
234-2304	ICON, 2.3 x 4mm Emergency Screw
234-2305	ICON, 2.3 x 5mm Emergency Screw
234-2306	ICON, 2.3 x 6mm Emergency Screw
234-2308	ICON, 2.3 x 8mm Emergency Screw
234-2310	ICON, 2.3 x 10mm Emergency Screw
234-2312	ICON, 2.3 x 12mm Emergency Screw
234-2314	ICON, 2.3 x 14mm Emergency Screw
234-2316	ICON, 2.3 x 16mm Emergency Screw
234-2318	ICON, 2.3 x 18mm Emergency Screw
234-2320	ICON, 2.3 x 20mm Emergency Screw
234-2322	ICON, 2.3 x 22mm Emergency Screw
234-2324	ICON, 2.3 x 24mm Emergency Screw

2.3mm Emergency Screw Tags



220-0615-99 TAG, ER

P/N	Description
220-0615-04	4
220-0615-05	5
220-0615-06	6
220-0615-08	8
220-0615-10	10
220-0615-12	12
220-0615-14	14
220-0615-16	16
220-0615-18	18
220-0615-20	20
220-0615-22	22
220-0615-24	24

ICON MMF Screws



P/N	Description
299-2008	ICON, 2.0mm MMF Screw, 8mm
299-2011	ICON, 2.0mm MMF Screw, 11mm

ICON MMF ScrewTags



220-0624-99 TAG, MMF SCREW, MMF

P/N	Description
220-0624-08	8
220-0624-11	11

2.0mm INSTRUMENTS

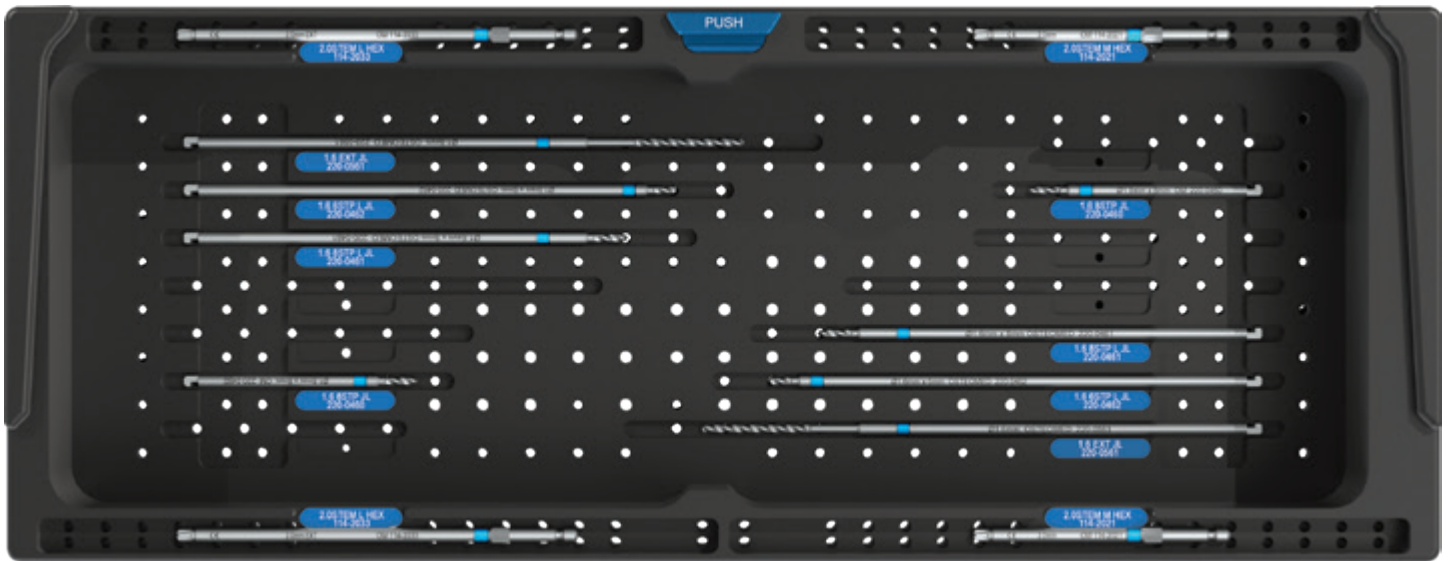

2.0mm Drills

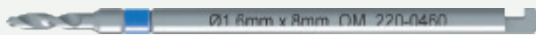

220-0460 1.6mm Pilot Drill, 8mm Stop, J-Latch

1.6 8STP JL
220-0460

220-0640-158



220-0461 1.6mm Extended Pilot Drill, 8mm Stop, J-Latch

1.6 8STP L JL
220-0461

220-0640-159

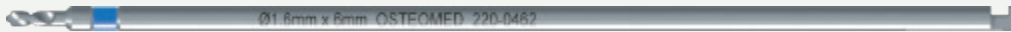

220-0462 1.6mm Extended Pilot Drill, 6mm Stop, J-Latch

1.6 6STP L JL
220-0462

220-0640-160



220-0561 1.6mm Pilot Drill, Long, Mandible System, J-Latch

1.6 EXT JL
220-0561

220-0640-153

2.0mm Drivers



114-2021 2.0mm Driver Stem, Medium, Hex Shank

2.0STEM M HEX
114-2021

220-0640-156







114-2033 2.0mm Driver Stem, Long, Hex Shank

2.0STEM L HEX
114-2033

220-0640-157

2.0mm ADDITIONAL INSTRUMENTS

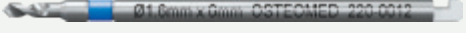
2.0mm Drills

	220-0003 1.6mm Pilot Drill, J-Latch	1.6 JL 220-0003
		220-0640-131
	220-0004 1.6mm Pilot Drill, Long, J-Latch	1.6 LONG JL 220-0004
		220-0640-132
	220-0012 1.6mm Pilot Drill, 6mm Stop, J-Latch	1.6 6MM STP J 220-0012
		220-0640-134
	220-0013 1.6mm Pilot Drill, 4mm Stop, J-Latch	1.6 4MM ST J 220-0013
		220-0640-135
	220-0898 1.6mm ICON Rainbow Drill, Long Cannula, J-Latch	1.6 RAINBW JL 220-0898
		220-0640-136

ICON FACIAL PLATING SYSTEM Rainbow Drill Guide Chart

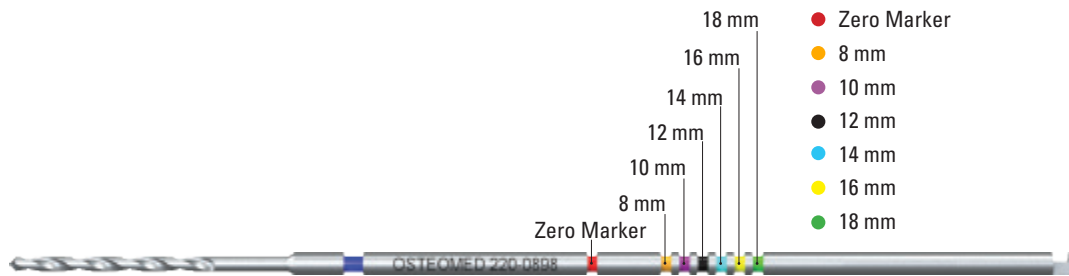

220-0898 1.6mm ICON Rainbow Drill, Long Cannula, J-Latch

220-0899 2.0mm ICON Rainbow Drill, Long Cannula, J-Latch

2.0mm Drivers

	114-2015 2.0mm Driver Stem, Short, Hex Shank	2.0STEM S HEX 114-2015
		220-0640-155

ING MODULE

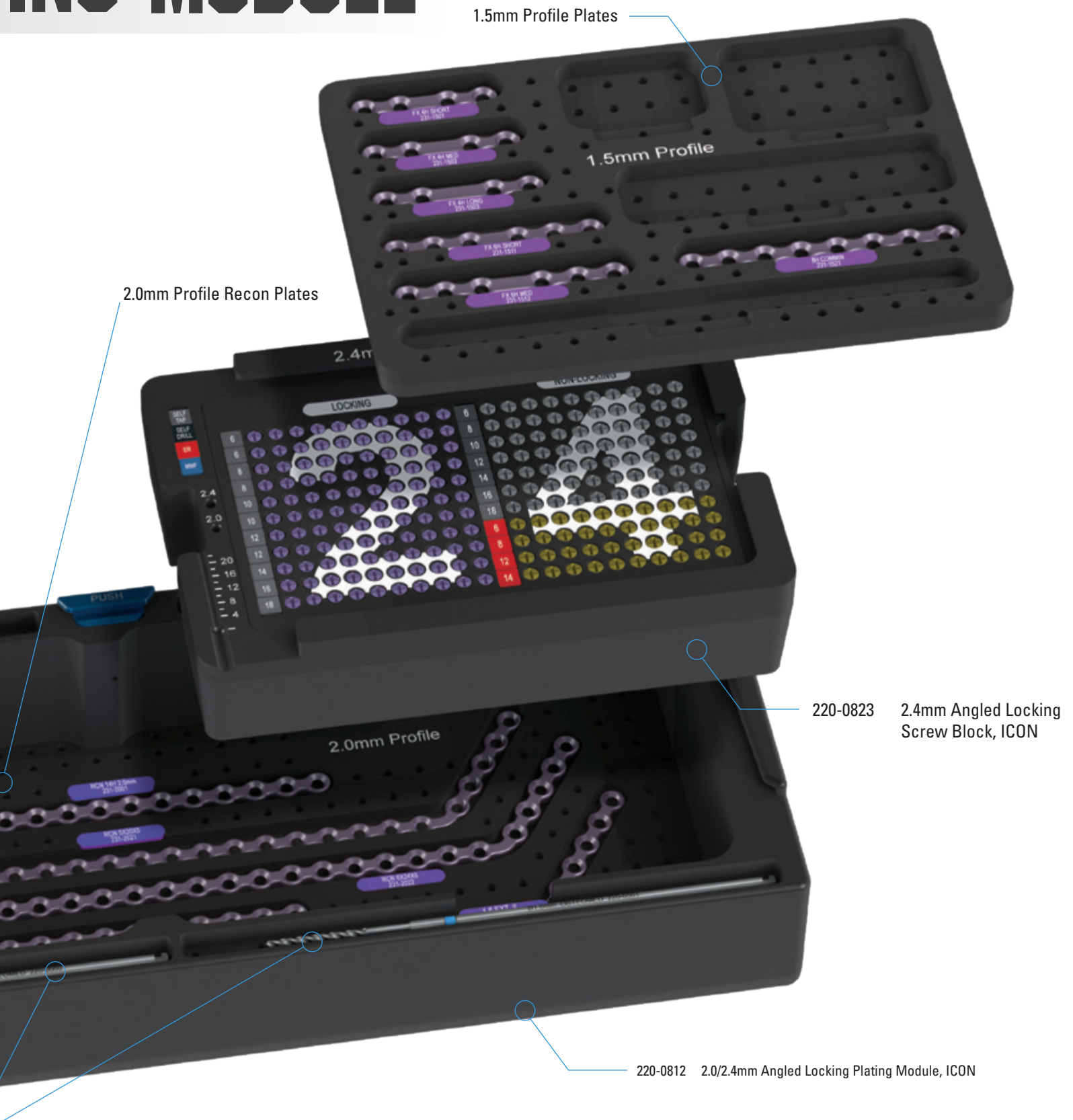

1.5mm Profile Plates

1.5mm Profile

2.0mm Profile Recon Plates

2.4mm

2.0mm Profile

220-0823 2.4mm Angled Locking Screw Block, ICON

220-0812 2.0/2.4mm Angled Locking Plating Module, ICON

1.0mm PROFILE PLATES

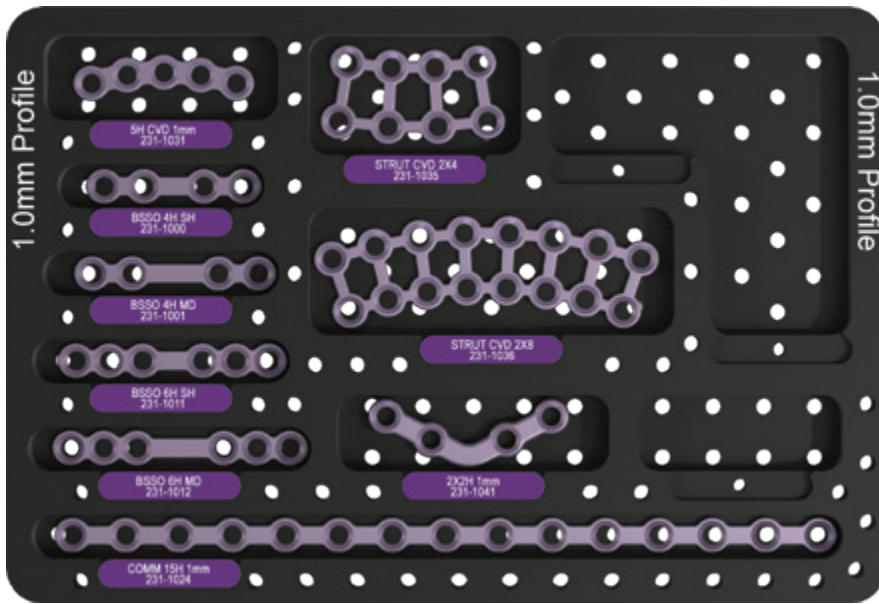

	231-1000 ICON, 4 Hole BSSO Plate, Locking, Short, 1.0mm Thick		220-0643-01 Plate Tag - BSSO 4H SH
	231-1000T	ICON, 4 Hole BSSO Plate, Locking, Short, 1.0mm Thick, TEMPLATE	

	231-1001 ICON, 4 Hole BSSO Plate, Locking, Medium, 1.0mm Thick		220-0643-02 Plate Tag - BSSO 4H MD
	231-1001T	ICON, 4 Hole BSSO Plate, Locking, Medium, 1.0mm Thick, TEMPLATE	

	231-1011 ICON, 6 Hole BSSO Plate, Locking, Small, 1.0mm Thick		220-0643-04 Plate Tag - BSSO 6H SH
	231-1011T	ICON, 6 Hole BSSO Plate, Locking, Small, 1.0mm Thick, TEMPLATE	

	231-1012 ICON, 6 Hole BSSO Plate, Locking, Medium, 1.0mm Thick		220-0643-05 Plate Tag - BSSO 6H MD
	231-1012T	ICON, 6 Hole BSSO Plate, Locking, Medium, 1.0mm Thick, TEMPLATE	

	231-1024 ICON, 15 Hole Comminution Plate, Locking, 1.0mm Thick		220-0643-09 Plate Tag - COMM 15H 1mm
	231-1024T	ICON, 15 Hole Comminution Plate, Locking, 1.0mm Thick, TEMPLATE	

	231-1031 ICON, 5 Hole Curved Plate, Locking, 1.0mm Thick		220-0643-10 Plate Tag - 5H CVD 1mm
	231-1031T	ICON, 5 Hole Curved Plate, Locking, 1.0mm Thick, TEMPLATE	

1.0mm PROFILE PLATES



231-1035
 ICON, 2x4 Curved Strut Plate,
 Locking, 1.0mm Thick

STRUT CVD 2X4
 231-1035

220-0643-13
 Plate Tag - STRUT CVD 2X4

231-1035T ICON, 2x4 Curved Strut Plate, Locking, 1.0mm Thick, TEMPLATE



231-1036
 ICON, 2x8 Curved Strut Plate,
 Locking 1.0mm Thick

STRUT CVD 2X8
 231-1036

220-0643-14
 Plate Tag - STRUT CVD 2X8

231-1036T ICON, 2x8 Curved Strut Plate, Locking 1.0mm Thick, TEMPLATE



231-1041
 ICON, 2x2 Locking Plate,
 1.0mm Thick

2X2H 1mm
 231-1041

220-0643-15
 Plate Tag - 2X2H 1mm

231-1041T ICON, 2x2 Locking Plate, 1.0mm Thick, TEMPLATE

ADDITIONAL 1.0mm PLATES

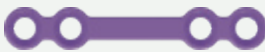

231-1002
 ICON, 4 Hole BSSO Plate, Locking,
 Long, 1.0mm Thick

BSSO 4H LG
 231-1002

220-0643-03
 Plate Tag - BSSO 4H LG

231-1002T ICON, 4 Hole BSSO Plate, Locking, Long, 1.0mm Thick, TEMPLATE



231-1021
 ICON, 4 Hole Locking Plate,
 1.0mm Thick

4H STR 1mm
 231-1021

220-0643-06
 Plate Tag - 4H STR 1mm

231-1021T ICON, 4 Hole Locking Plate, 1.0mm Thick, TEMPLATE



231-1022
 ICON, 6 Hole Straight Plate,
 Locking, 1.0mm Thick

6H STR 1mm
 231-1022

220-0643-07
 Plate Tag - 6H STR 1mm

231-1022T ICON, 6 Hole Straight Plate, Locking, 1.0mm Thick, TEMPLATE



231-1023
 ICON, 18 Hole Straight Plate,
 Locking, 1.0mm Thick

18H STR 1mm
 231-1023

220-0643-08
 Plate Tag - 18H STR 1mm

231-1023T ICON, 18 Hole Straight Plate, Locking, 1.0mm Thick, TEMPLATE



231-1032
 ICON, 7 Hole Curved Plate,
 Locking, 1.0mm Thick

7H CVD 1mm
 231-1032

220-0643-11
 Plate Tag - 7H CVD 1mm

231-1032T ICON, 7 Hole Curved Plate, Locking, 1.0mm Thick, TEMPLATE



231-1033
 ICON, 9 Hole Curved Plate,
 Locking, 1.0mm Thick

9H CVD 1mm
 231-1033

220-0643-12
 Plate Tag - 9H CVD 1mm

231-1033T ICON, 9 Hole Curved Plate, Locking, 1.0mm Thick, TEMPLATE

ADDITIONAL 1.0mm PLATES



231-1042
 ICON, 3x3 Locking Plate,
 1.0mm Thick

3X3H 1mm
 231-1042

220-0643-16
 Plate Tag - 3X3H 1mm

231-1042T *ICON, 3x3 Locking Plate, 1.0mm Thick, TEMPLATE*



231-1051
 ICON, Condylar Trauma Plate,
 4 Hole, 1.0mm Thick

4H CONDYLAR
 231-1051

220-0643-17
 Plate Tag - 4H CONDYLAR

231-1051T *ICON, Condylar Trauma Plate, 4 Hole, 1.0mm Thick, TEMPLATE*



231-1052
 ICON, Condylar Trauma Plate,
 5 Hole, 1.0mm Thick

5H CONDYLAR
 231-1052

220-0643-18
 Plate Tag - 5H CONDYLAR

231-1052T *ICON, Condylar Trauma Plate, 5 Hole, 1.0mm Thick, TEMPLATE*



231-1053
 ICON, Condylar, Trauma Plate,
 6 Hole, Left

6H CONDYLAR LT
 231-1053

220-0643-19
 Plate Tag - 6H CONDYLAR LT

231-1053T *ICON, Condylar, Trauma Plate, 6 Hole, Left, TEMPLATE*



231-1054
 ICON, Condylar, Trauma Plate,
 6 Hole, Right

6H CONDYLAR RT
 231-1054

220-0643-20
 Plate Tag - 6H CONDYLAR RT

231-1054T *ICON, Condylar, Trauma Plate, 6 Hole, Right, TEMPLATE*



231-1055
 ICON, Mandibular Fan Plate,
 1mm Thick

MANDBL FAN
 231-1055

220-0643-21
 Plate Tag - MANDBL FAN

231-1055T *ICON, Mandibular Fan Plate, 1mm Thick, TEMPLATE*

1.5mm PROFILE PLATES

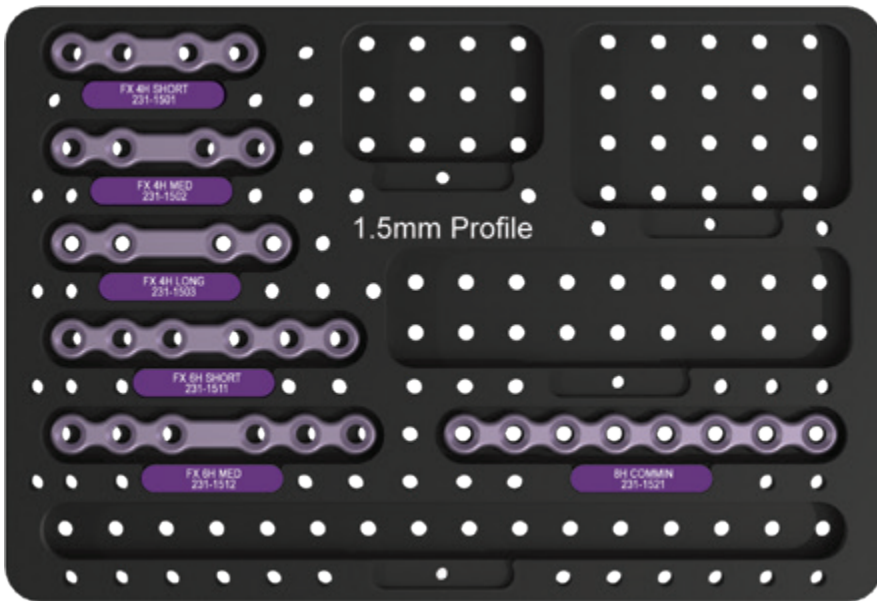

231-1501
ICON, 4 Hole Fracture Plate,
Locking, Short, 1.5mm Thick

FX 4H SHORT
231-1501

220-0643-22
Plate Tag - FX 4H SHORT

231-1501T ICON, 4 Hole Fracture Plate, Locking, Short, 1.5mm Thick, TEMPLATE



231-1502
ICON, 4 Hole Fracture Plate,
Locking, Medium, 1.5mm Thick

FX 4H MED
231-1502

220-0643-23
Plate Tag - FX 4H MED

231-1502T ICON, 4 Hole Fracture Plate, Locking Medium, 1.5mm Thick, TEMPLATE

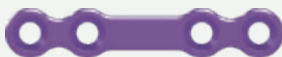

231-1503
ICON, 4 Hole Fracture Plate,
Locking, Long, 1.5mm Thick

FX 4H LONG
231-1503

220-0643-24
Plate Tag - FX 4H LONG

231-1503T ICON, 4 Hole Fracture Plate, Locking, Long, 1.5mm Thick, TEMPLATE



231-1511
ICON, 6 Hole Fracture Plate,
Locking, Short, 1.5mm Thick

FX 6H SHORT
231-1511

220-0643-25
Plate Tag - FX 6H SHORT

231-1511T ICON, 6 Hole Fracture Plate, Locking, Short, 1.5mm Thick, TEMPLATE



231-1512
ICON, 6 Hole Fracture Plate,
Locking, Medium, 1.5mm Thick

FX 6H MED
231-1512

220-0643-26
Plate Tag - FX 6H MED

231-1512T ICON, 6 Hole Fracture Plate, Locking, Medium, 1.5mm Thick, TEMPLATE



231-1521
ICON, 8 Hole Comminution Plate,
1.5mm Thick

8H COMMIN
231-1521

220-0643-27
Plate Tag - 8H COMMIN

231-1521T ICON, 8 Hole Comminution Plate, 1.5mm Thick, TEMPLATE

ADDITIONAL 1.5mm PLATES



231-1513
 ICON, 6 Hole Fracture Plate,
 Locking, Long, 1.5mm Thick

FX 6H LONG
 231-1513

220-0643-91
 Plate Tag - FX 6H LONG

231-1513T *ICON, 6 Hole Fracture Plate, Locking, Long, 1.5mm Thick, TEMPLATE*



231-1531
 ICON, 2x2 Locking Plate,
 1.5mm thick

2X2H 1.5mm
 231-1531

220-0643-29
 Plate Tag - 2X2H 1.5mm

231-1531T *ICON, 2x2 Locking Plate, 1.5mm thick, TEMPLATE*



231-1532
 ICON, 3x3 Locking Plate,
 1.5mm Thick

3X3H 1.5mm
 231-1532

220-0643-30
 Plate Tag - 3X3H 1.5mm

231-1532T *ICON, 3x3 Locking Plate, 1.5mm Thick, TEMPLATE*

2.0mm PROFILE RECON PLATES

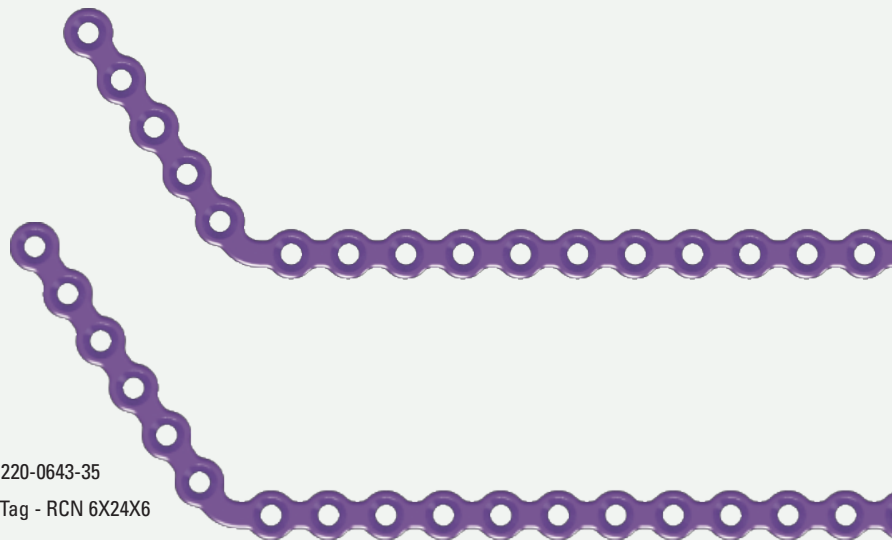
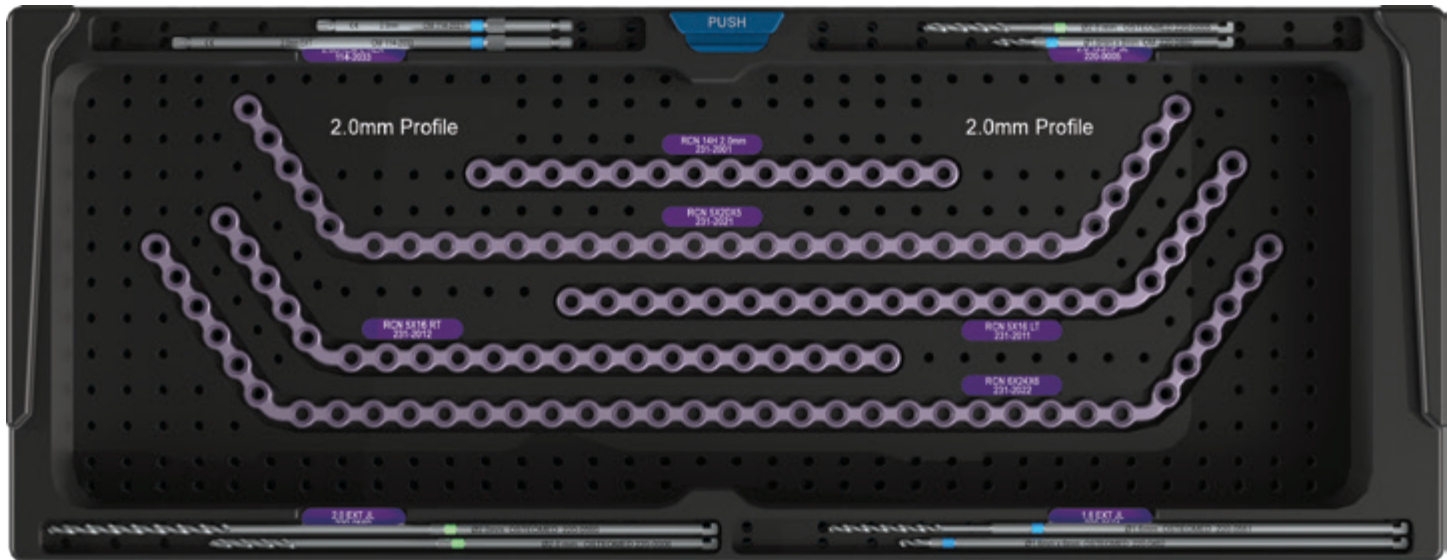

231-2022
 ICON, 6x24x6 Reconstruction
 Plate, Locking, 2.0mm Thick

RCN 6X24X6
 231-2022

220-0643-35
 Plate Tag - RCN 6X24X6

231-2022T *ICON, 6x24x6 Reconstruction Plate, Locking, 2.0mm Thick, TEMPLATE*

2.0mm PROFILE RECON PLATES



231-2001
ICON, 14 Hole Reconstruction
Plate, Locking, 2.0mm Thick

RCN 14H 2.0mm
231-2001

220-0643-31
Plate Tag - RCN 14H 2.0mm

231-2001T *ICON, 14 Hole Reconstruction Plate, Locking, 2.0mm Thick, TEMPLATE*



231-2011
ICON, 5x16 Hole Reconstruction
Plate, Locking, Left, 2.0mm Thick

RCN 5X16 LT
231-2011

220-0643-32
Plate Tag - RCN 5X16 LT

231-2011T *ICON, 5x16 Hole Reconstruction Plate, Locking, Left, 2.0mm Thick, TEMPLATE*



231-2012
ICON, 5x16 Hole Reconstruction
Plate, Locking, Right, 2.0mm Thick

RCN 5X16 RT
231-2012

220-0643-33
Plate Tag - RCN 5X16 RT

231-2012T *ICON, 5x16 Hole Reconstruction Plate, Locking, Right, 2.0mm Thick, TEMPLATE*

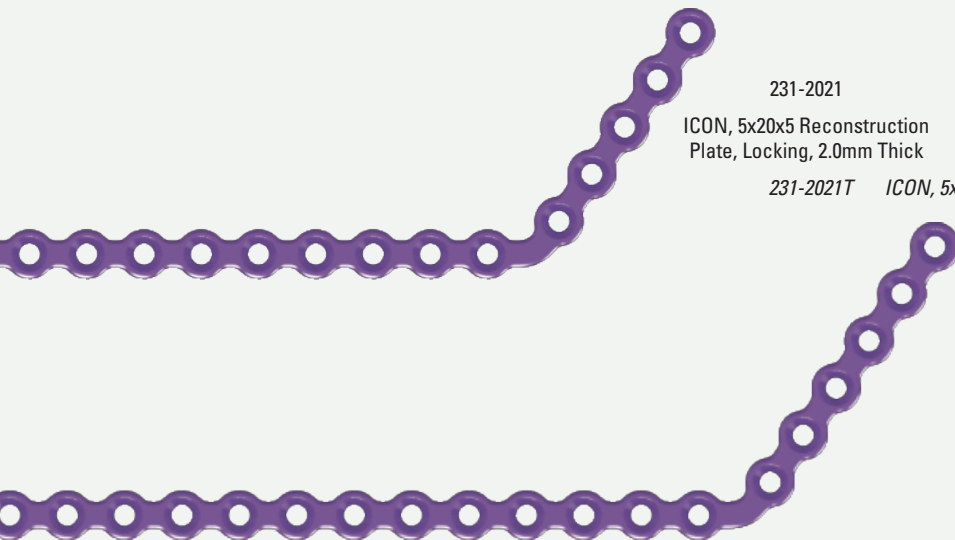

231-2021
ICON, 5x20x5 Reconstruction
Plate, Locking, 2.0mm Thick

RCN 5X20X5
231-2021

220-0643-34
Plate Tag - RCN 5X20X5

231-2021T *ICON, 5x20x5 Reconstruction Plate, Locking, 2.0mm Thick, TEMPLATE*

2.0mm LOCKING SCREW BLOCK

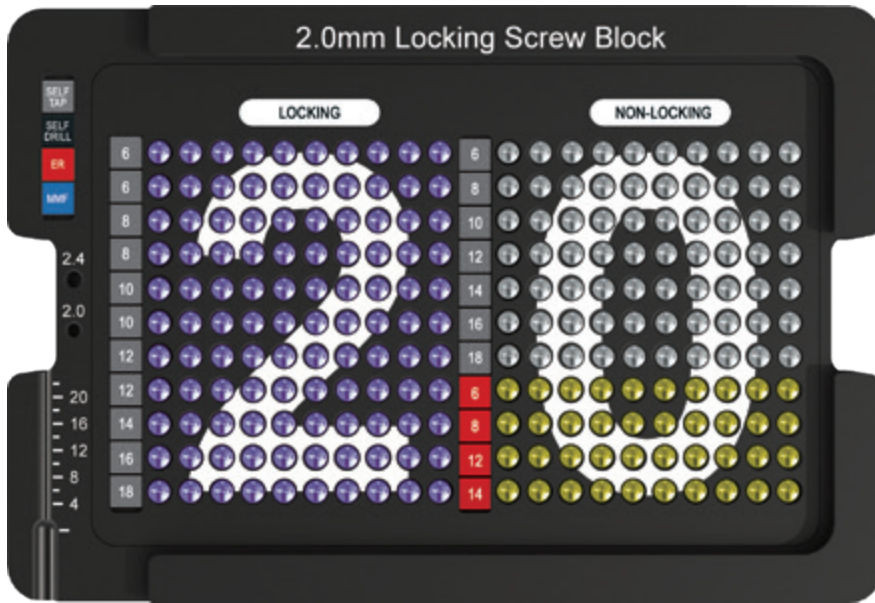

220-0822 2.0mm Angled Locking Screw Block, ICON

LOCKING

220-0641-37 LOCKING White ID Tag, LOCKING

NON-LOCKING

220-0641-38 NON-LOCKING White ID Tag, NON-LOCKING

2.0mm Angled Locking Self Tapping Screws



P/N	Description
232-2005	ICON, 2.0 x 5mm Locking Screw, Self-Tapping
232-2006	ICON, 2.0 x 6mm Locking Screw, Self-Tapping
232-2008	ICON, 2.0 x 8mm Locking Screw, Self-Tapping
232-2010	ICON, 2.0 x 10mm Locking Screw, Self-Tapping
232-2012	ICON, 2.0 x 12mm Locking Screw, Self-Tapping
232-2014	ICON, 2.0 x 14mm Locking Screw, Self-Tapping
232-2016	ICON, 2.0 x 16mm Locking Screw, Self-Tapping
232-2018	ICON, 2.0 x 18mm Locking Screw, Self-Tapping
232-2020	ICON, 2.0 x 20mm Locking Screw, Self-Tapping
232-2022	ICON, 2.0 x 22mm Locking Screw, Self-Tapping

2.0mm Angled Locking Self Tapping Screw Tags



220-0614-99 TAG, SELF TAP

P/N	Description
220-0614-05	5
220-0614-06	6
220-0614-08	8
220-0614-10	10
220-0614-12	12
220-0614-14	14
220-0614-16	16
220-0614-18	18
220-0614-20	20
220-0614-22	22

2.0mm LOCKING SCREW BLOCK

2.0mm Self Tapping Screws



P/N	Description
234-2004	ICON, 2.0 x 4mm Screw, Self-Tapping
234-2005	ICON, 2.0 x 5mm Screw, Self-Tapping
234-2006	ICON, 2.0 x 6mm Screw, Self-Tapping
234-2008	ICON, 2.0 x 8mm Screw, Self-Tapping
234-2010	ICON, 2.0 x 10mm Screw, Self-Tapping
234-2012	ICON, 2.0 x 12mm Screw, Self-Tapping
234-2014	ICON, 2.0 x 14mm Screw, Self-Tapping
234-2016	ICON, 2.0 x 16mm Screw, Self-Tapping
234-2018	ICON, 2.0 x 18mm Screw, Self-Tapping
234-2020	ICON, 2.0 x 20mm Screw, Self-Tapping
234-2022	ICON, 2.0 x 22mm Screw, Self-Tapping
234-2024	ICON, 2.0 x 24mm Screw, Self-Tapping

2.0mm Self Tapping Screw Tags



220-0614-99 TAG, SELF TAP

P/N	Description
220-0614-04	4
220-0614-05	5
220-0614-06	6
220-0614-08	8
220-0614-10	10
220-0614-12	12
220-0614-14	14
220-0614-16	16
220-0614-18	18
220-0614-20	20
220-0614-22	22
220-0614-24	24

2.3mm Emergency Screws



P/N	Description
234-2304	ICON, 2.3 x 4mm Emergency Screw
234-2305	ICON, 2.3 x 5mm Emergency Screw
234-2306	ICON, 2.3 x 6mm Emergency Screw
234-2308	ICON, 2.3 x 8mm Emergency Screw
234-2310	ICON, 2.3 x 10mm Emergency Screw
234-2312	ICON, 2.3 x 12mm Emergency Screw
234-2314	ICON, 2.3 x 14mm Emergency Screw
234-2316	ICON, 2.3 x 16mm Emergency Screw
234-2318	ICON, 2.3 x 18mm Emergency Screw
234-2320	ICON, 2.3 x 20mm Emergency Screw
234-2322	ICON, 2.3 x 22mm Emergency Screw
234-2324	ICON, 2.3 x 24mm Emergency Screw

2.3mm Emergency Screw Tags



220-0615-99 TAG, ER

P/N	Description
220-0615-04	4
220-0615-05	5
220-0615-06	6
220-0615-08	8
220-0615-10	10
220-0615-12	12
220-0615-14	14
220-0615-16	16
220-0615-18	18
220-0615-20	20
220-0615-22	22
220-0615-24	24

ICON MMF Screws



P/N	Description
299-2008	ICON, 2.0mm MMF Screw, 8mm
299-2011	ICON, 2.0mm MMF Screw, 11mm

ICON MMF ScrewTags



220-0624-99 TAG, MMF SCREW, MMF

P/N	Description
220-0624-08	8
220-0624-11	11

2.4mm LOCKING SCREW BLOCK

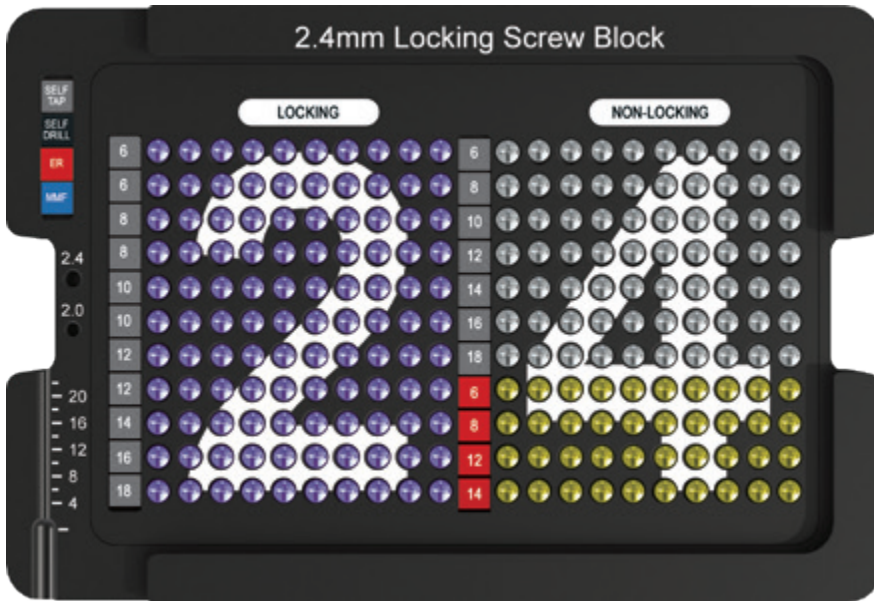

LOCKING

220-0641-37 LOCKING White ID Tag, LOCKING

NON-LOCKING

220-0641-38 NON-LOCKING White ID Tag, NON-LOCKING

220-0823 2.4mm Angled Locking Screw Block, ICON

2.4mm Angled Locking Self Tapping Screws



P/N	Description
232-2406	ICON, 2.4mm x 6mm Locking Screw, Self-Tapping
232-2408	ICON, 2.4mm x 8mm Locking Screw, Self-Tapping
232-2410	ICON, 2.4mm x 10mm Locking Screw, Self-Tapping
232-2412	ICON, 2.4mm x 12mm Locking Screw, Self-Tapping
232-2414	ICON, 2.4mm x 14mm Locking Screw, Self-Tapping
232-2416	ICON, 2.4mm x 16mm Locking Screw, Self-Tapping
232-2418	ICON, 2.4mm x 18mm Locking Screw, Self-Tapping
232-2420	ICON, 2.4mm x 20mm Locking Screw, Self-Tapping
232-2422	ICON, 2.4mm x 22mm Locking Screw, Self-Tapping

2.4mm Angled Locking Self Tapping Screw Tags



220-0614-99 TAG, SELF TAP

P/N	Description
220-0614-06	6
220-0614-08	8
220-0614-10	10
220-0614-12	12
220-0614-14	14
220-0614-16	16
220-0614-18	18
220-0614-20	20
220-0614-22	22

2.4mm LOCKING SCREW BLOCK

2.4mm Self Tapping Screws



P/N	Description	P/N	Description
206-2404	2.4mm x 4mm Standard Screw	220-0614-04	4
206-2405	2.4mm x 5mm Standard Screw	220-0614-05	5
206-2406	2.4mm x 6mm Standard Screw	220-0614-06	6
206-2408	2.4mm x 8mm Standard Screw	220-0614-08	8
206-2410	2.4mm x 10mm Standard Screw	220-0614-10	10
206-2412	2.4mm x 12mm Standard Screw	220-0614-12	12
206-2414	2.4mm x 14mm Standard Screw	220-0614-14	14
206-2416	2.4mm x 16mm Standard Screw	220-0614-16	16
206-2418	2.4mm x 18mm Standard Screw	220-0614-18	18
206-2420	2.4mm x 20mm Standard Screw	220-0614-20	20
206-2422	2.4mm x 22mm Standard Screw	220-0614-22	22

2.4mm Self Tapping Screw Tags

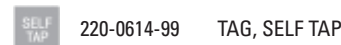

2.7mm Emergency Screws



P/N	Description	P/N	Description
206-2704	2.7mm x 4mm Safety Screw	220-0615-04	4
206-2706	2.7mm x 6mm Safety Screw	220-0615-06	6
206-2708	2.7mm x 8mm Safety Screw	220-0615-08	8
206-2710	2.7mm x 10mm Safety Screw	220-0615-10	10
206-2712	2.7mm x 12mm Safety Screw	220-0615-12	12
206-2714	2.7mm x 14mm Safety Screw	220-0615-14	14
206-2716	2.7mm x 16mm Safety Screw	220-0615-16	16
206-2718	2.7mm x 18mm Safety Screw	220-0615-18	18
206-2720	2.7mm x 20mm Safety Screw	220-0615-20	20

2.7mm Emergency Screw Tags

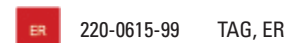

ADDITIONAL 2.7mm LOCKING SCREWS

2.7mm Angled Locking Emergency Screws



P/N	Description	P/N	Description
232-2706	ICON, 2.7mm x 6mm Angled Locking Emergency Screw	220-0615-06	6
232-2708	ICON, 2.7mm x 8mm Angled Locking Emergency Screw	220-0615-08	8
232-2710	ICON, 2.7mm x 10mm Angled Locking Emergency Screw	220-0615-10	10
232-2712	ICON, 2.7mm x 12mm Angled Locking Emergency Screw	220-0615-12	12
232-2714	ICON, 2.7mm x 14mm Angled Locking Emergency Screw	220-0615-14	14
232-2716	ICON, 2.7mm x 16mm Angled Locking Emergency Screw	220-0615-16	16
232-2718	ICON, 2.7mm x 18mm Angled Locking Emergency Screw	220-0615-18	18
232-2720	ICON, 2.7mm x 20mm Angled Locking Emergency Screw	220-0615-20	20
232-2722	ICON, 2.7mm x 22mm Angled Locking Emergency Screw	220-0615-22	22

2.7mm Angled Locking Emergency Tags

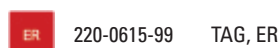

2.0/2.4mm INSTRUMENTS

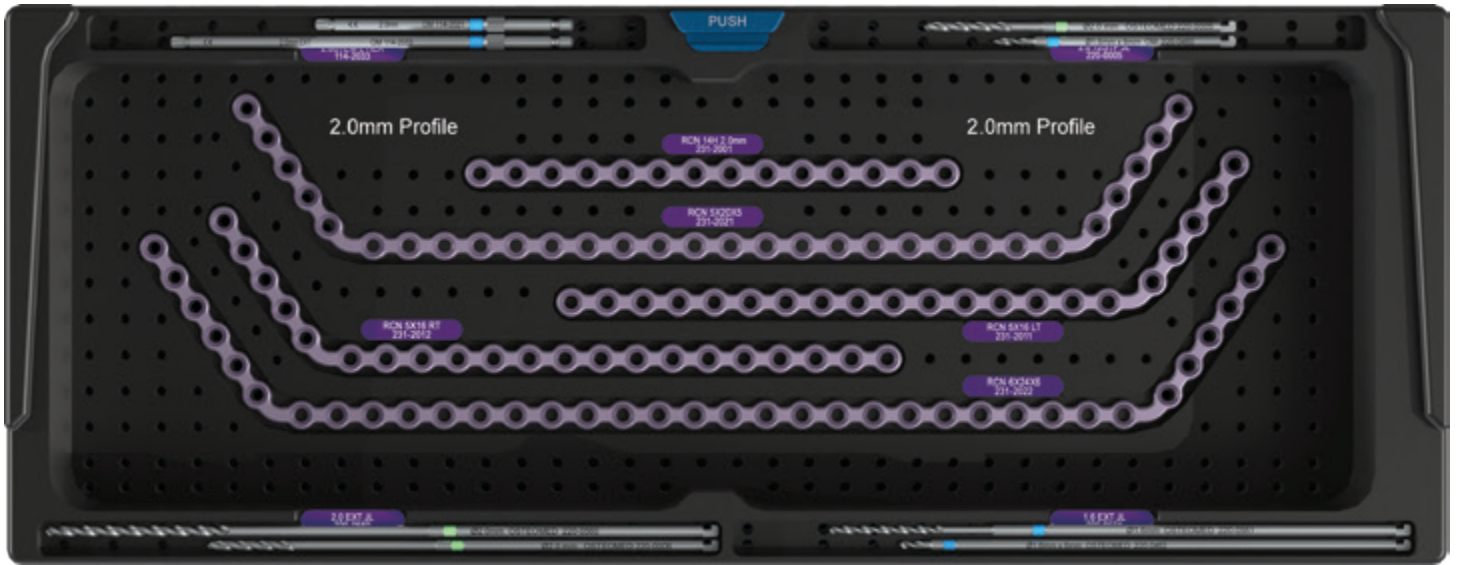

2.0/2.4mm Drills



220-0005 2.0mm Pilot Drill, J-Latch, 12mm

2.0 12STP JL
220-0005

220-643-46



220-0006 2.0mm Pilot Drill, Long, J-Latch

2.0 PD EXT J
220-0006

220-643-47



220-0460 1.6MM PILOT DRILL, 8MM STOP, J-LATCH

1.6 8STP JL
220-0460

220-640-158



220-0462 1.6MM PILOT DRILL, 6MM STOP, LONG, J-LATCH

1.6 6STP L JL
220-0462

220-640-160



220-0560 2.0mm Pilot Drill, Long, Mandible System, J-Latch

2.0 EXT JL
220-0560

220-643-79



220-0561 1.6mm Pilot Drill, Long, Mandible System, J-Latch

1.6 EXT JL
220-0561

220-640-153

2.0/2.4mm Drivers



114-2021 2.0mm Driver Stem, Medium, Hex Shank

2.0STEM M HEX
114-2021

220-640-156









114-2033 2.0mm Driver Stem, Long, Hex Shank

2.0STEM L HEX
114-2033

220-640-157

2.0/2.4mm ADDITIONAL INSTRUMENTS

2.0/2.4mm Drills

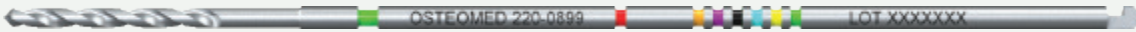
	Ø1.6 mm OSTEOMED 220-0003	1.6 JL 220-0003
220-0003	1.6mm Pilot Drill, J-Latch	220-0640-131
	Ø1.6 mm OSTEOMED 220-0004	1.6 LONG JL 220-0004
220-0004	1.6mm Pilot Drill, Long, J-Latch	220-0640-132
	Ø1.6 mm x 6mm OSTEOMED 220-0012	1.6 6MM STP J 220-0012
220-0012	1.6mm Pilot Drill, 6mm Stop, J-Latch	220-0640-134
	Ø1.6 mm x 4mm OSTEOMED 220-0013	1.6 4MM ST J 220-0013
220-0013	1.6mm Pilot Drill, 4mm Stop, J-Latch	220-0640-135
	Ø1.6 mm x 8mm OSTEOMED 220-0461	1.6 8STP L JL 220-0461
220-0461	1.6mm Extended Pilot Drill, 8mm Stop, J-Latch	220-0640-160
	OSTEOMED 220-0898	1.6 RAINBW JL 220-0898
220-0898	1.6mm ICON Rainbow Drill, Long Cannula, J-Latch	220-0640-136
	OSTEOMED 220-0899 LOT XXXXXX	2.0 RAINBW JL 220-0899
220-0899	2.0mm ICON Rainbow Drill, Long Cannula, J-Latch	220-0643-90

ICON Rainbow Drill Guide Chart

FACIAL PLATING SYSTEM

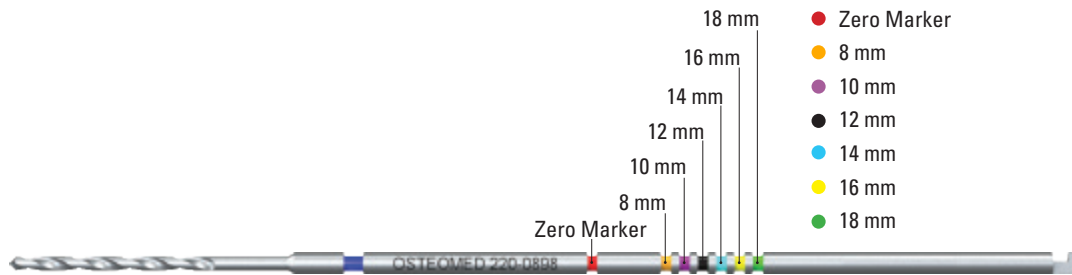

220-0898 1.6mm ICON Rainbow Drill, Long Cannula, J-Latch

220-0899 2.0mm ICON Rainbow Drill, Long Cannula, J-Latch

2.0/2.4mm Drivers

	Ø2.0mm OSTEOMED 114-2015	2.0STEM S HEX 114-2015
114-2015	2.0mm Driver Stem, Short, Hex Shank	220-0640-155



RECON PLATING MODULE

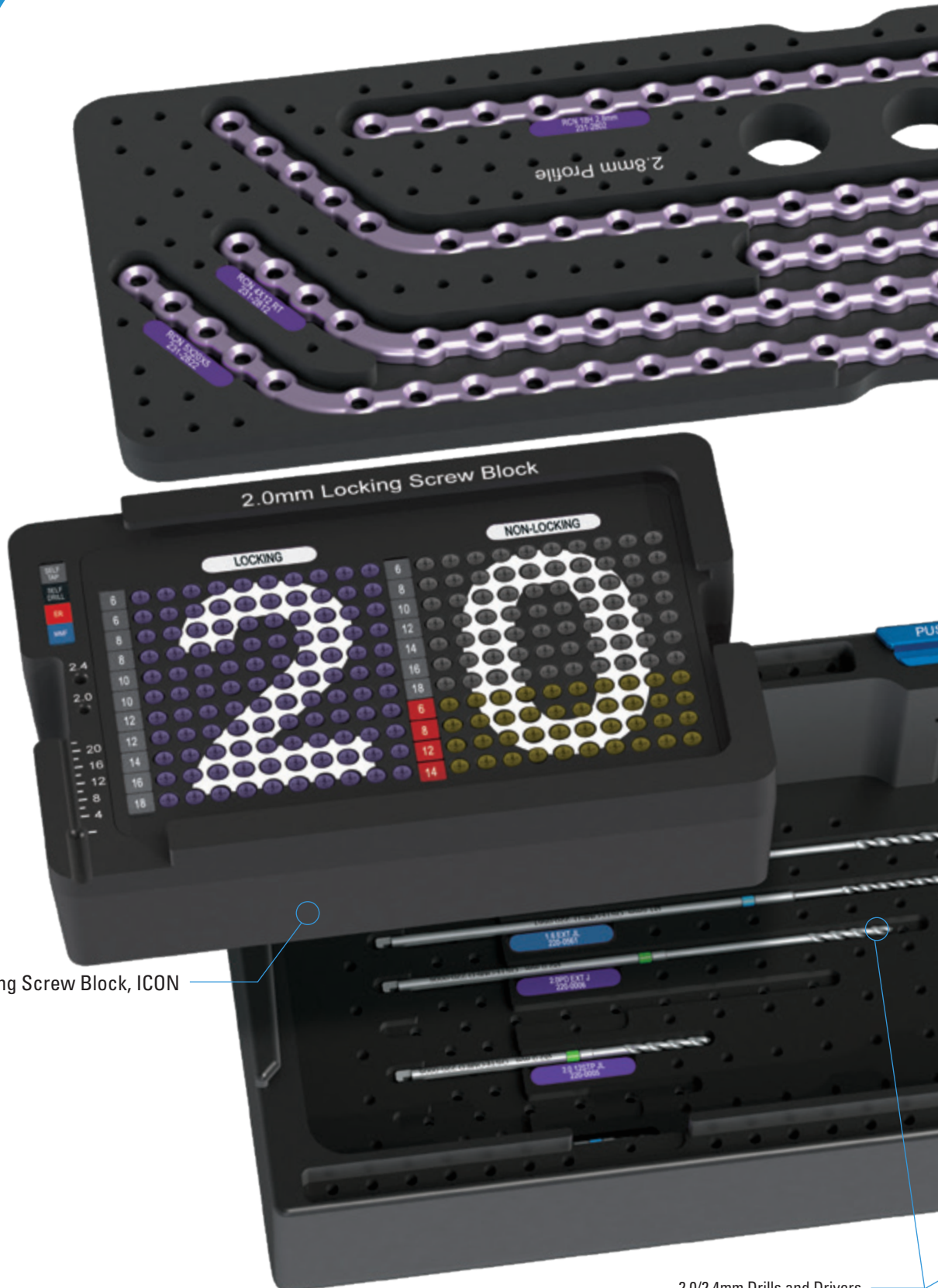

220-0822 2.0mm Angled Locking Screw Block, ICON

2.0/2.4mm Drills and Drivers

E

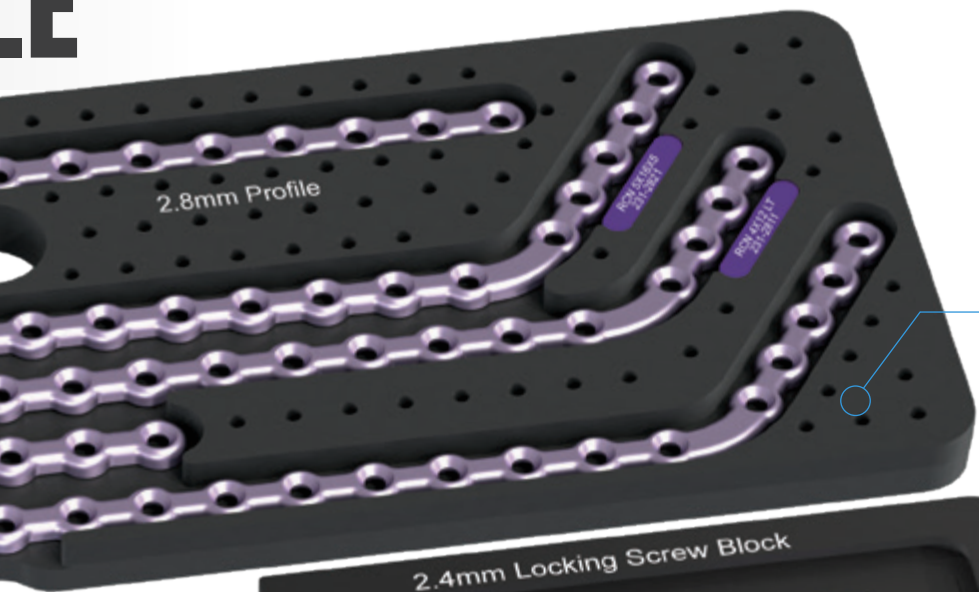

2.8mm Reconstruction Plates



220-0823 2.4mm Angled Locking Screw Block, ICON



220-0813 Angled Locking Reconstruction Module, ICON

2.8mm RECON PLATES*

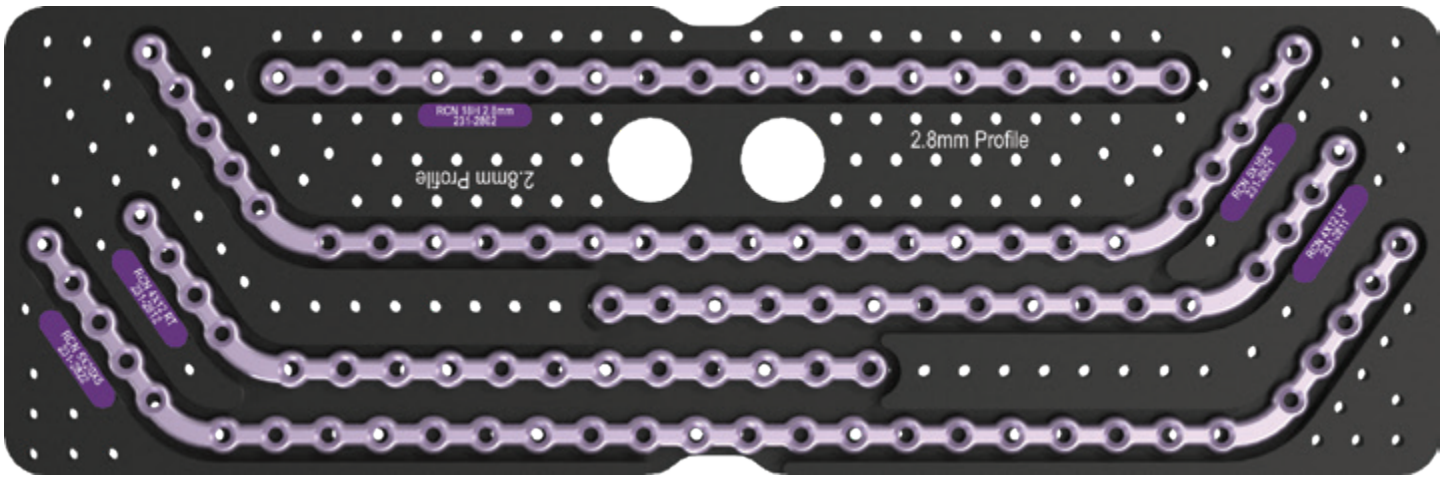

231-2801
 ICON, 14 Hole Reconstruction
 Plate, Locking, 2.8mm Thick

RCN 14H 2.8mm
 231-2801

220-0643-36
 Plate Tag - RCN 14H 2.8mm

231-2801T *ICON, 14 Hole Reconstruction Plate, Locking, TEMPLATE*



231-2802
 ICON, 18 Hole Reconstruction
 Plate, Locking, 2.8mm Thick

RCN 18H 2.8mm
 231-2802

220-0643-37
 Plate Tag - RCN 18H 2.8mm

231-2802T *ICON, 18 Hole Reconstruction Plate, Locking, TEMPLATE*



231-2811
 ICON, 4x12 Hole Reconstruction
 Plate, Locking, Left, 2.8mm Thick

RCN 4X12 LT
 231-2811

220-0643-38
 Plate Tag - RCN 4X12 LT

231-2811T *ICON, 4x12 Hole Reconstruction Plate, Locking, Left, TEMPLATE*

2.8mm RECON PLATES*

* Optional



231-2812

ICON, 4x12 Hole Reconstruction
Plate, Locking, Right, 2.8mm Thick

RCN 4X12 RT
231-2812

220-0643-39

Plate Tag - RCN 4X12 RT

231-2812T ICON, 4x12 Hole Reconstruction Plate, Locking, Right, TEMPLATE

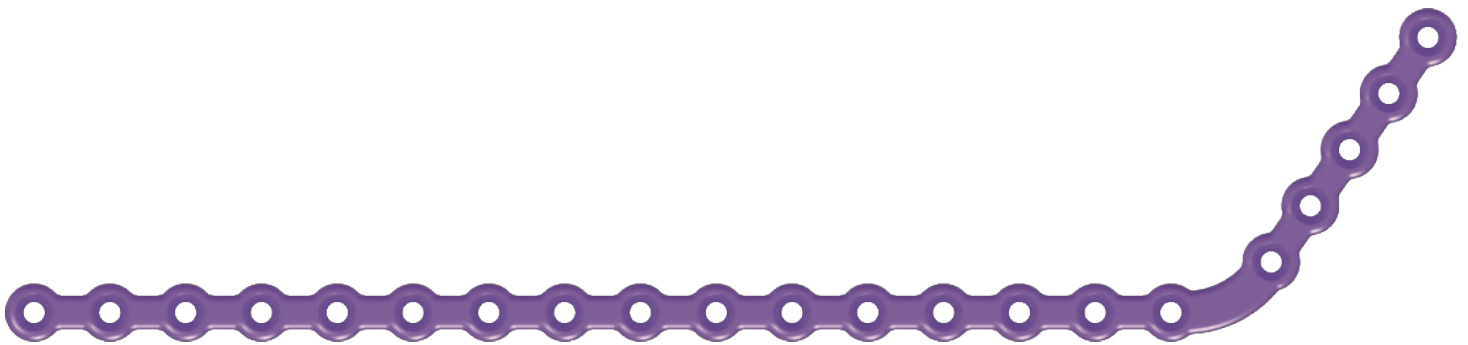

231-2813

ICON, 5x16 Hole Reconstruction
Plate, Locking, Left, 2.8mm Thick

RCN 5X16 LT
231-2813

220-0643-40

Plate Tag - RCN 5X16 LT

231-2813T ICON, 5x16 Hole Reconstruction Plate, Locking, Left, TEMPLATE

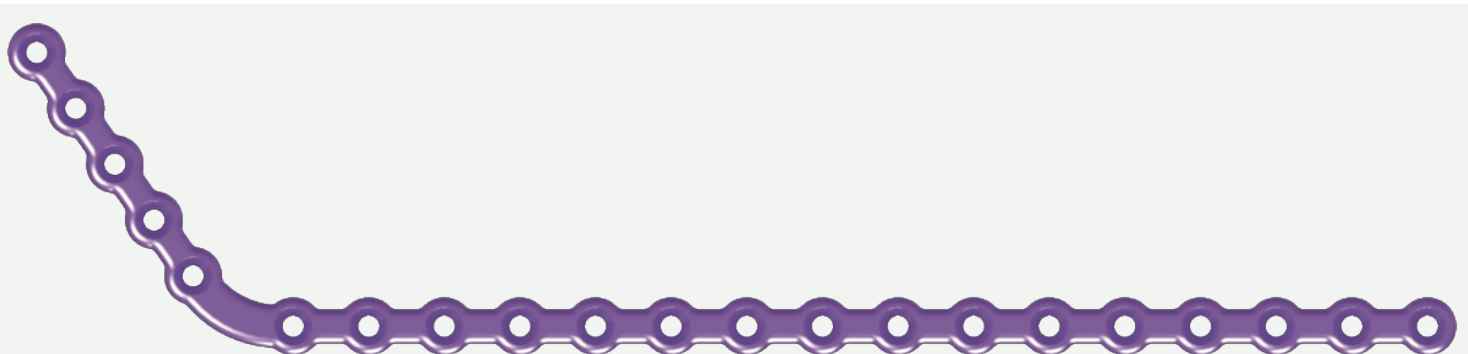

231-2814

ICON, 5x16 Hole Reconstruction
Plate, Locking, Right, 2.8mm Thick

RCN 5X16 RT
231-2814

220-0643-41

Plate Tag - RCN 5X16 RT

231-2814T ICON, 5x16 Hole Reconstruction Plate, Locking, Right, TEMPLATE

2.8mm RECON PLATES*

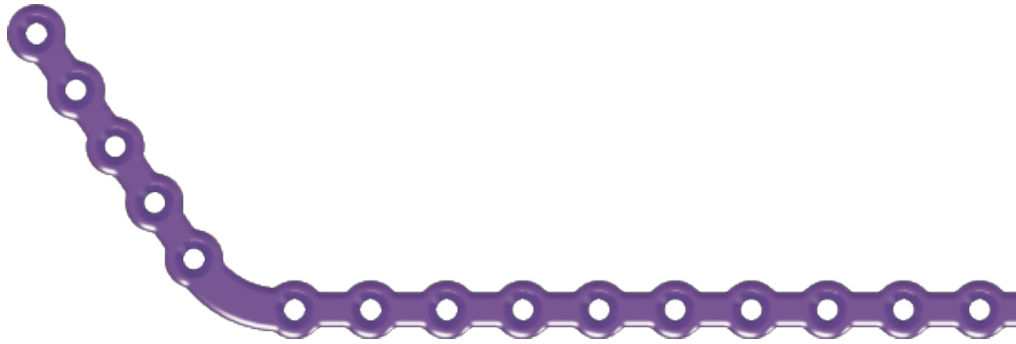

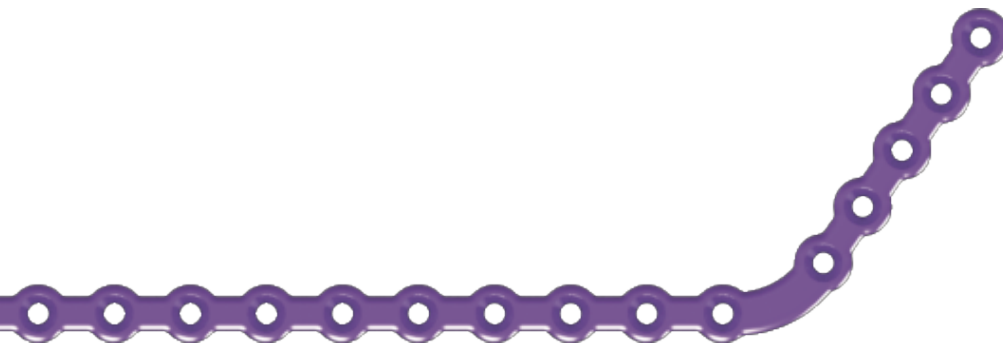
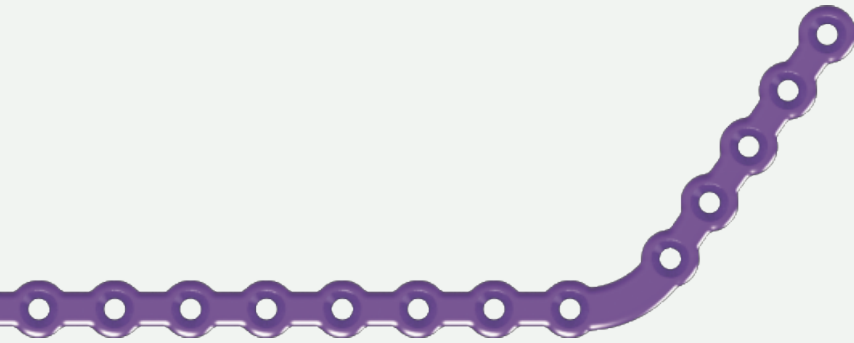

231-2822

ICON, 5x20x5 Hole Reconstruction
Plate, Locking, 2.8mm Thick

231-2822T *ICON, 5x20x5 Recon Plate, Locking, TEMPLATE*

RCN 5X20X5
231-2822

220-0643-43

Plate Tag - RCN 5X20X5

2.0mm LOCKING SCREW BLOCK

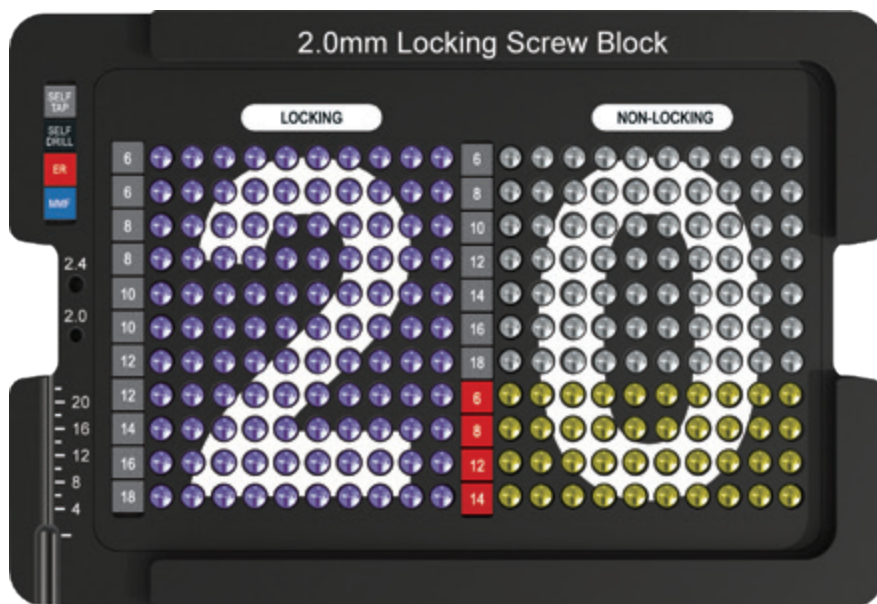

LOCKING

220-0641-37 LOCKING White ID Tag, LOCKING

NON-LOCKING

220-0641-38 NON-LOCKING White ID Tag, NON-LOCKING

220-0822 2.0mm Angled Locking Screw Block, ICON

2.0mm Angled Locking Self Tapping Screws



P/N	Description
232-2005	ICON, 2.0 x 5mm Locking Screw, Self-Tapping
232-2006	ICON, 2.0 x 6mm Locking Screw, Self-Tapping
232-2008	ICON, 2.0 x 8mm Locking Screw, Self-Tapping
232-2010	ICON, 2.0 x 10mm Locking Screw, Self-Tapping
232-2012	ICON, 2.0 x 12mm Locking Screw, Self-Tapping
232-2014	ICON, 2.0 x 14mm Locking Screw, Self-Tapping
232-2016	ICON, 2.0 x 16mm Locking Screw, Self-Tapping
232-2018	ICON, 2.0 x 18mm Locking Screw, Self-Tapping
232-2020	ICON, 2.0 x 20mm Locking Screw, Self-Tapping
232-2022	ICON, 2.0 x 22mm Locking Screw, Self-Tapping

2.0mm Angled Locking Self Tapping Screw Tags



220-0614-99 TAG, SELF TAP

P/N	Description
220-0614-05	5
220-0614-06	6
220-0614-08	8
220-0614-10	10
220-0614-12	12
220-0614-14	14
220-0614-16	16
220-0614-18	18
220-0614-20	20
220-0614-22	22

2.0mm LOCKING SCREW BLOCK

2.0mm Self Tapping Screws



P/N	Description
234-2004	ICON, 2.0 x 4mm Screw, Self-Tapping
234-2005	ICON, 2.0 x 5mm Screw, Self-Tapping
234-2006	ICON, 2.0 x 6mm Screw, Self-Tapping
234-2008	ICON, 2.0 x 8mm Screw, Self-Tapping
234-2010	ICON, 2.0 x 10mm Screw, Self-Tapping
234-2012	ICON, 2.0 x 12mm Screw, Self-Tapping
234-2014	ICON, 2.0 x 14mm Screw, Self-Tapping
234-2016	ICON, 2.0 x 16mm Screw, Self-Tapping
234-2018	ICON, 2.0 x 18mm Screw, Self-Tapping
234-2020	ICON, 2.0 x 20mm Screw, Self-Tapping
234-2022	ICON, 2.0 x 22mm Screw, Self-Tapping
234-2024	ICON, 2.0 x 24mm Screw, Self-Tapping

2.0mm Self Tapping Screw Tags



220-0614-99 TAG, SELF TAP

P/N	Description
220-0614-04	4
220-0614-05	5
220-0614-06	6
220-0614-08	8
220-0614-10	10
220-0614-12	12
220-0614-14	14
220-0614-16	16
220-0614-18	18
220-0614-20	20
220-0614-22	22
220-0614-24	24

2.3mm Emergency Screws



P/N	Description
234-2304	ICON, 2.3 x 4mm Emergency Screw
234-2305	ICON, 2.3 x 5mm Emergency Screw
234-2306	ICON, 2.3 x 6mm Emergency Screw
234-2308	ICON, 2.3 x 8mm Emergency Screw
234-2310	ICON, 2.3 x 10mm Emergency Screw
234-2312	ICON, 2.3 x 12mm Emergency Screw
234-2314	ICON, 2.3 x 14mm Emergency Screw
234-2316	ICON, 2.3 x 16mm Emergency Screw
234-2318	ICON, 2.3 x 18mm Emergency Screw
234-2320	ICON, 2.3 x 20mm Emergency Screw
234-2322	ICON, 2.3 x 22mm Emergency Screw
234-2324	ICON, 2.3 x 24mm Emergency Screw

2.3mm Emergency Screw Tags



220-0615-99 TAG, ER

P/N	Description
220-0615-04	4
220-0615-05	5
220-0615-06	6
220-0615-08	8
220-0615-10	10
220-0615-12	12
220-0615-14	14
220-0615-16	16
220-0615-18	18
220-0615-20	20
220-0615-22	22
220-0615-24	24

ICON MMF Screws



P/N	Description
299-2008	ICON, 2.0mm MMF Screw, 8mm
299-2011	ICON, 2.0mm MMF Screw, 11mm

ICON MMF ScrewTags



220-0624-99 TAG, MMF SCREW, MMF

P/N	Description
220-0624-08	8
220-0624-11	11

2.4mm LOCKING SCREW BLOCK

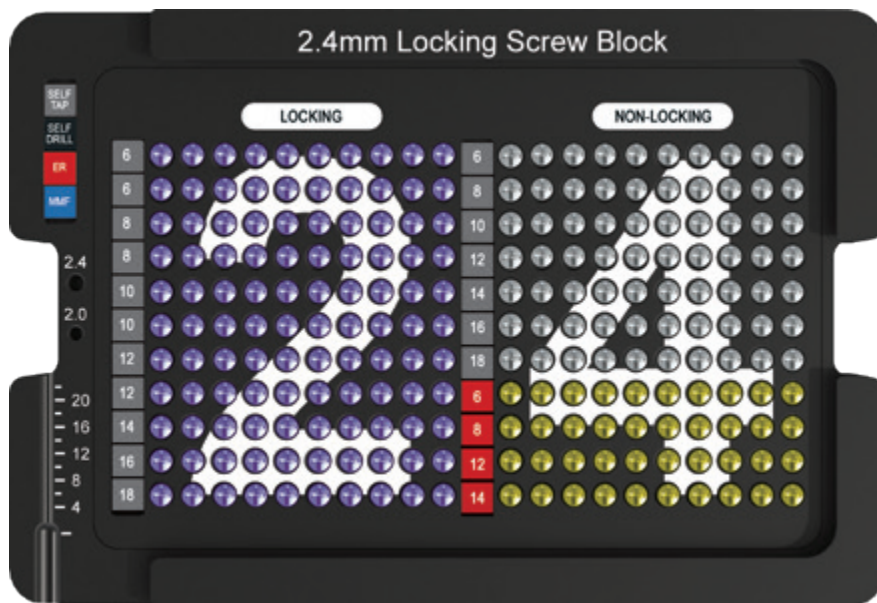

LOCKING

220-0641-37 LOCKING White ID Tag, LOCKING

NON-LOCKING

220-0641-38 NON-LOCKING White ID Tag, NON-LOCKING

220-0823 2.4mm Angled Locking Screw Block, ICON

2.4mm Angled Locking Self Tapping Screws



P/N	Description
232-2406	ICON, 2.4mm x 6mm Locking Screw, Self-Tapping
232-2408	ICON, 2.4mm x 8mm Locking Screw, Self-Tapping
232-2410	ICON, 2.4mm x 10mm Locking Screw, Self-Tapping
232-2412	ICON, 2.4mm x 12mm Locking Screw, Self-Tapping
232-2414	ICON, 2.4mm x 14mm Locking Screw, Self-Tapping
232-2416	ICON, 2.4mm x 16mm Locking Screw, Self-Tapping
232-2418	ICON, 2.4mm x 18mm Locking Screw, Self-Tapping
232-2420	ICON, 2.4mm x 20mm Locking Screw, Self-Tapping
232-2422	ICON, 2.4mm x 22mm Locking Screw, Self-Tapping

2.4mm Angled Locking Self Tapping Screw Tags



220-0614-99 TAG, SELF TAP

P/N	Description
220-0614-06	6
220-0614-08	8
220-0614-10	10
220-0614-12	12
220-0614-14	14
220-0614-16	16
220-0614-18	18
220-0614-20	20
220-0614-22	22

2.4mm LOCKING SCREW BLOCK

2.4mm Self Tapping Screws



P/N	Description	P/N	Description
206-2404	2.4mm x 4mm Standard Screw	220-0614-04	4
206-2405	2.4mm x 5mm Standard Screw	220-0614-05	5
206-2406	2.4mm x 6mm Standard Screw	220-0614-06	6
206-2408	2.4mm x 8mm Standard Screw	220-0614-08	8
206-2410	2.4mm x 10mm Standard Screw	220-0614-10	10
206-2412	2.4mm x 12mm Standard Screw	220-0614-12	12
206-2414	2.4mm x 14mm Standard Screw	220-0614-14	14
206-2416	2.4mm x 16mm Standard Screw	220-0614-16	16
206-2418	2.4mm x 18mm Standard Screw	220-0614-18	18
206-2420	2.4mm x 20mm Standard Screw	220-0614-20	20
206-2422	2.4mm x 22mm Standard Screw	220-0614-22	22

2.4mm Self Tapping Screw Tags



P/N	Description
220-0614-99	TAG, SELF TAP

2.7mm Emergency Screws



P/N	Description	P/N	Description
206-2704	2.7mm x 4mm Safety Screw	220-0615-04	4
206-2706	2.7mm x 6mm Safety Screw	220-0615-06	6
206-2708	2.7mm x 8mm Safety Screw	220-0615-08	8
206-2710	2.7mm x 10mm Safety Screw	220-0615-10	10
206-2712	2.7mm x 12mm Safety Screw	220-0615-12	12
206-2714	2.7mm x 14mm Safety Screw	220-0615-14	14
206-2716	2.7mm x 16mm Safety Screw	220-0615-16	16
206-2718	2.7mm x 18mm Safety Screw	220-0615-18	18
206-2720	2.7mm x 20mm Safety Screw	220-0615-20	20

2.7mm Emergency Screw Tags

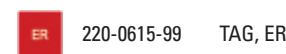

P/N	Description
220-0615-99	TAG, ER

ADDITIONAL 2.7mm LOCKING SCREWS

2.7mm Angled Locking Emergency Screws



P/N	Description	P/N	Description
232-2706	ICON, 2.7mm x 6mm Angled Locking Emergency Screw	220-0615-06	6
232-2708	ICON, 2.7mm x 8mm Angled Locking Emergency Screw	220-0615-08	8
232-2710	ICON, 2.7mm x 10mm Angled Locking Emergency Screw	220-0615-10	10
232-2712	ICON, 2.7mm x 12mm Angled Locking Emergency Screw	220-0615-12	12
232-2714	ICON, 2.7mm x 14mm Angled Locking Emergency Screw	220-0615-14	14
232-2716	ICON, 2.7mm x 16mm Angled Locking Emergency Screw	220-0615-16	16
232-2718	ICON, 2.7mm x 18mm Angled Locking Emergency Screw	220-0615-18	18
232-2720	ICON, 2.7mm x 20mm Angled Locking Emergency Screw	220-0615-20	20
232-2722	ICON, 2.7mm x 22mm Angled Locking Emergency Screw	220-0615-22	22

2.7mm Angled Locking Emergency Tags

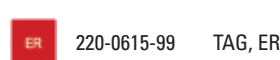



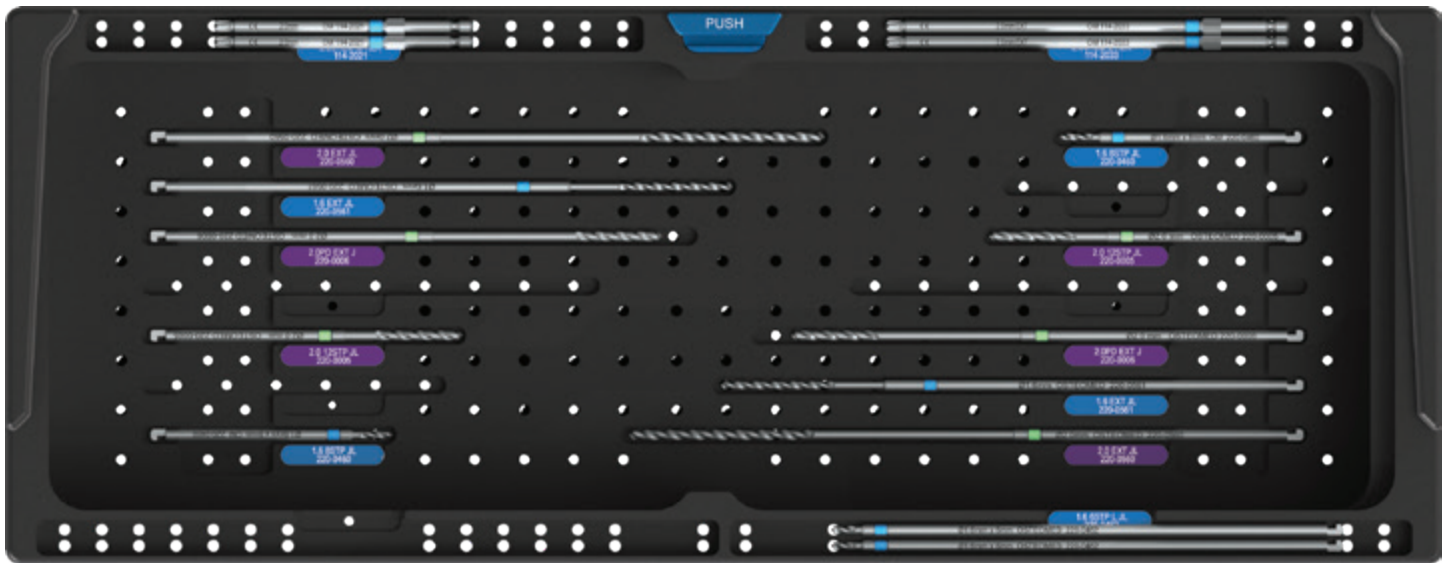

P/N	Description
220-0615-99	TAG, ER

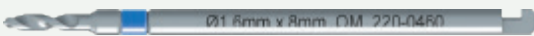

RECON INSTRUMENTS



Recon Drills







	Ø2.0 mm OSTEOMED 220-0005	2.0 12STP JL 220-0005
220-0005	2.0mm Pilot Drill, J-Latch, 12mm	220-643-46
	Ø2.0 mm OSTEOMED 220-0006	2.0 OPD EXT J 220-0006
220-0006	2.0mm Pilot Drill, Long, J-Latch	220-643-47
	Ø1.6mm x 8mm. OIM 220-0460	1.6 8STP JL 220-0460
220-0460	1.6mm Pilot Drill, 8mm Stop, J-Latch	220-640-158
	Ø1.6mm x 6mm OSTEOMED 220-0462	1.6 6STP L JL 220-0462
220-0462	1.6mm Pilot Drill, 6mm Stop, Long, J-Latch	220-640-160
	Ø2.0mm OSTEOMED 220-0560	2.0 EXT JL 220-0560
220-0560	2.0mm Pilot Drill, Long, Mandible System, J-Latch	220-643-79
	Ø1.6mm OSTEOMED 220-0561	1.6 EXT JL 220-0561
220-0561	1.6mm Pilot Drill, Long, Mandible System, J-Latch	220-640-153

Recon Drivers

	Ø2.0mm OIM 114-2021	2.0STEM M HEX 114-2021
114-2021	2.0mm Driver Stem, Medium, Hex Shank	220-640-156
	Ø2.0mm EXT OIM 114-2033	2.0STEM L HEX 114-2033
114-2033	2.0mm Driver Stem, Long, Hex Shank	220-640-157

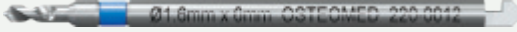
ADDITIONAL RECON INSTRUMENTS

2.0/2.4mm Drills

	Ø1.6 mm OSTEOMED 220-0003	1.6 JL 220-0003
220-0003	1.6mm Pilot Drill, J-Latch	220-0640-131
	Ø1.6 mm OSTEOMED 220-0004	1.6 LONG JL 220-0004
220-0004	1.6mm Pilot Drill, Long, J-Latch	220-0640-132
	Ø1.6mm x 6mm OSTEOMED 220-0012	1.6 6MM STP J 220-0012
220-0012	1.6mm Pilot Drill, 6mm Stop, J-Latch	220-0640-134
	Ø1.6mm x 4mm OSTEOMED 220-0013	1.6 4MM ST J 220-0013
220-0013	1.6mm Pilot Drill, 4mm Stop, J-Latch	220-0640-135
	Ø1.6mm x 8mm OSTEOMED 220-0461	1.6 8STP L JL 220-0461
220-0461	1.6mm Extended Pilot Drill, 8mm Stop, J-Latch	220-0640-160
	OSTEOMED 220-0898	1.6 RAINBW JL 220-0898
220-0898	1.6mm ICON Rainbow Drill, Long Cannula, J-Latch	220-0640-136
	OSTEOMED 220-0899 LOT XXXXXX	2.0 RAINBW JL 220-0899
220-0899	2.0mm ICON Rainbow Drill, Long Cannula, J-Latch	220-0643-90

ICON FACIAL PLATING SYSTEM Rainbow Drill Guide Chart

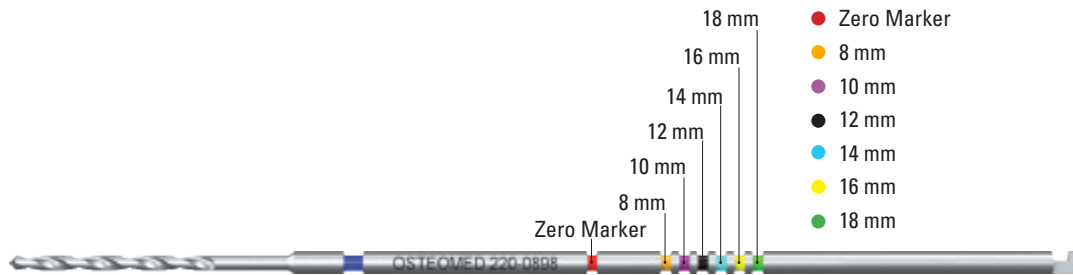

220-0898 1.6mm ICON Rainbow Drill, Long Cannula, J-Latch

220-0899 2.0mm ICON Rainbow Drill, Long Cannula, J-Latch

2.0/2.4mm Drivers

	CC 2.0mm OSTEOMED 114-2015	2.0STEM S HEX 114-2015
114-2015	2.0mm Driver Stem, Short, Hex Shank	220-0643-83

UTILITY TRAY

** Located underneath instrument racks*

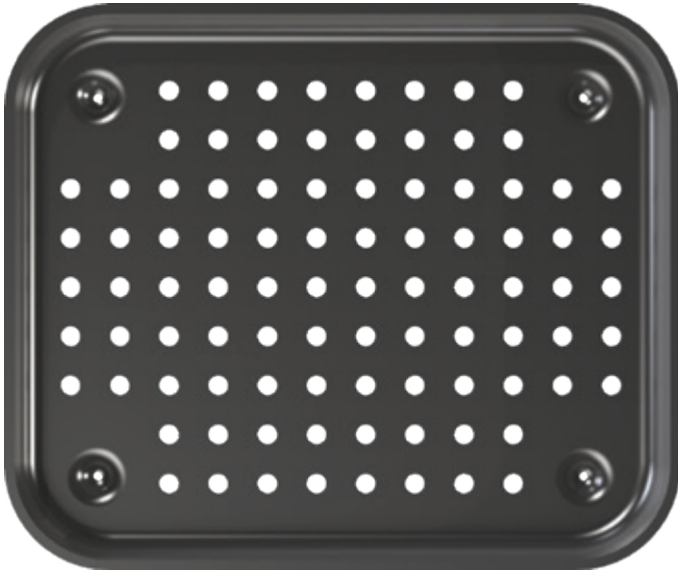

220-0801-06

Utility Tray, ICON

*Sized for:

- 1.2mm Plating Module
- Universal Bender
- Preformed Orbital Floor Plates

AUXILIARY TRAY

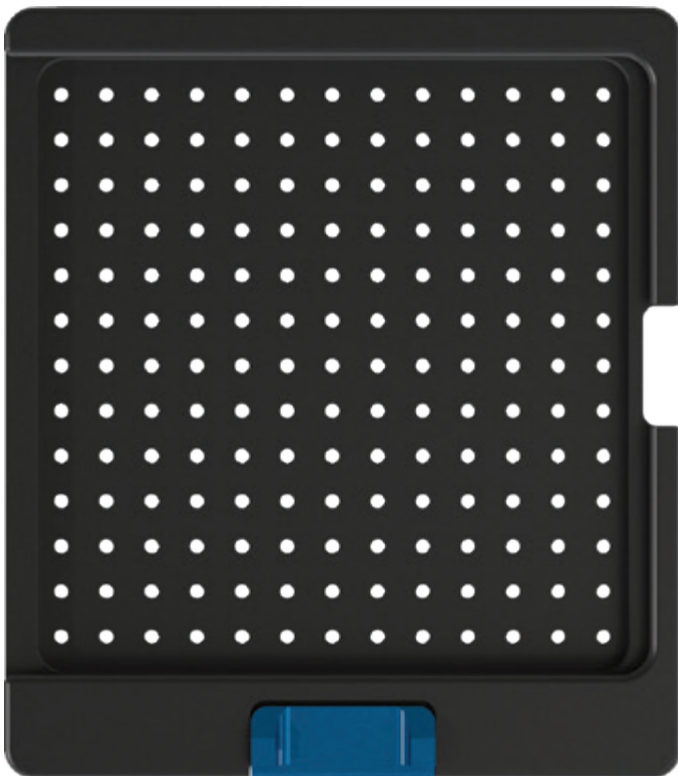

220-0801-05

Auxiliary Mesh Tray, ICON

OSTEOMED FACIAL PLATING SYSTEM

220-0802-01 Set ID Tag, OsteoMed Facial Plating System

OSTEOMED FACIAL TRAUMA SYSTEM

220-0802-02 Set ID Tag, OsteoMed Facial Trauma System

OSTEOMED MANDIBLE PLATING SYSTEM

220-0802-03 Set ID Tag, OsteoMed Mandible Plating System

OSTEOMED MIDFACE PLATING SYSTEM

220-0802-04 Set ID Tag, OsteoMed MidFace Plating System

OSTEOMED ORTHOGNATHIC PLATING SYSTEM

220-0802-05 Set ID Tag, OsteoMed Orthognathic Plating System



GENERAL INSTRUMENTS

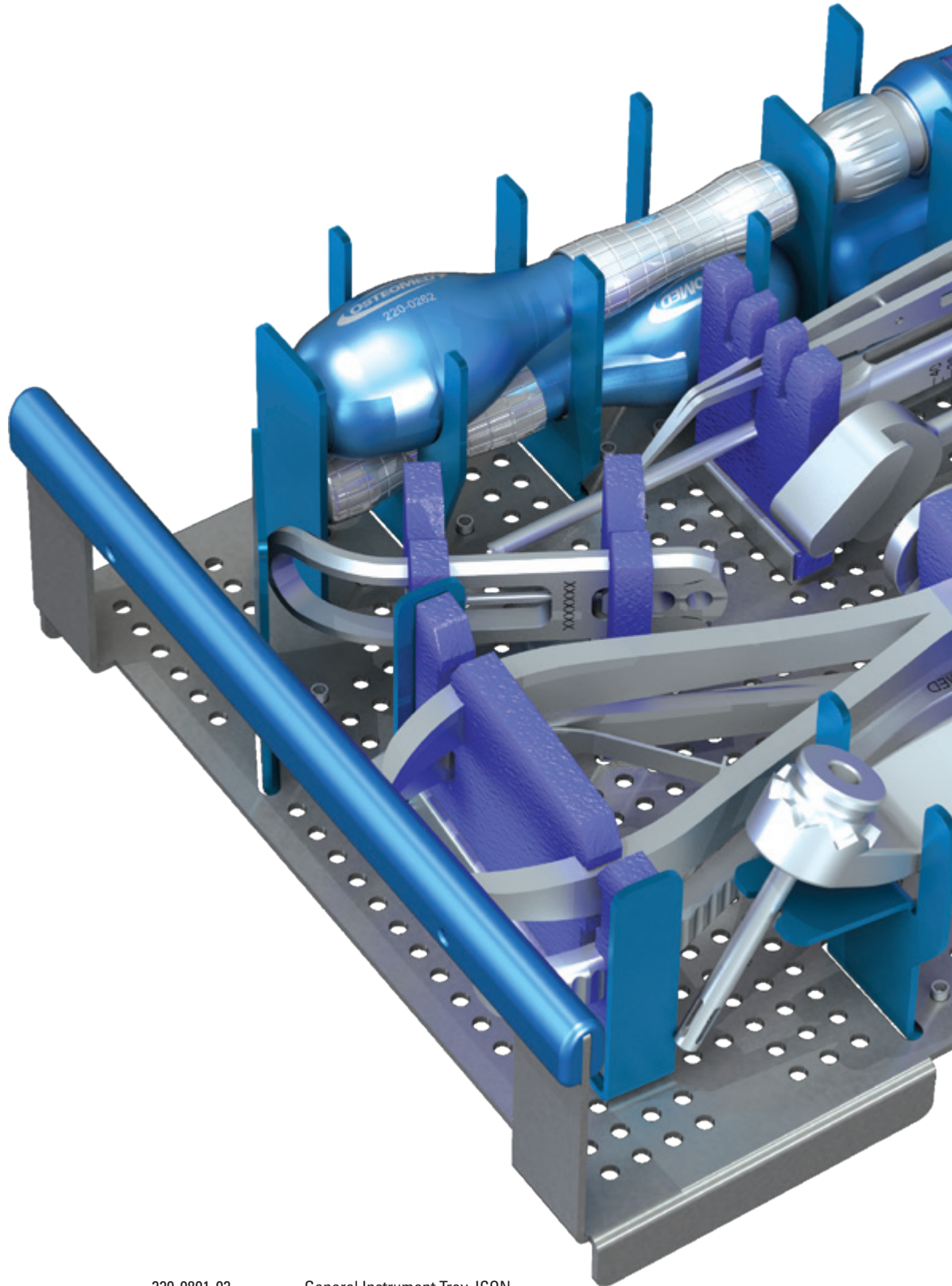

220-0801-02

General Instrument Tray, ICON

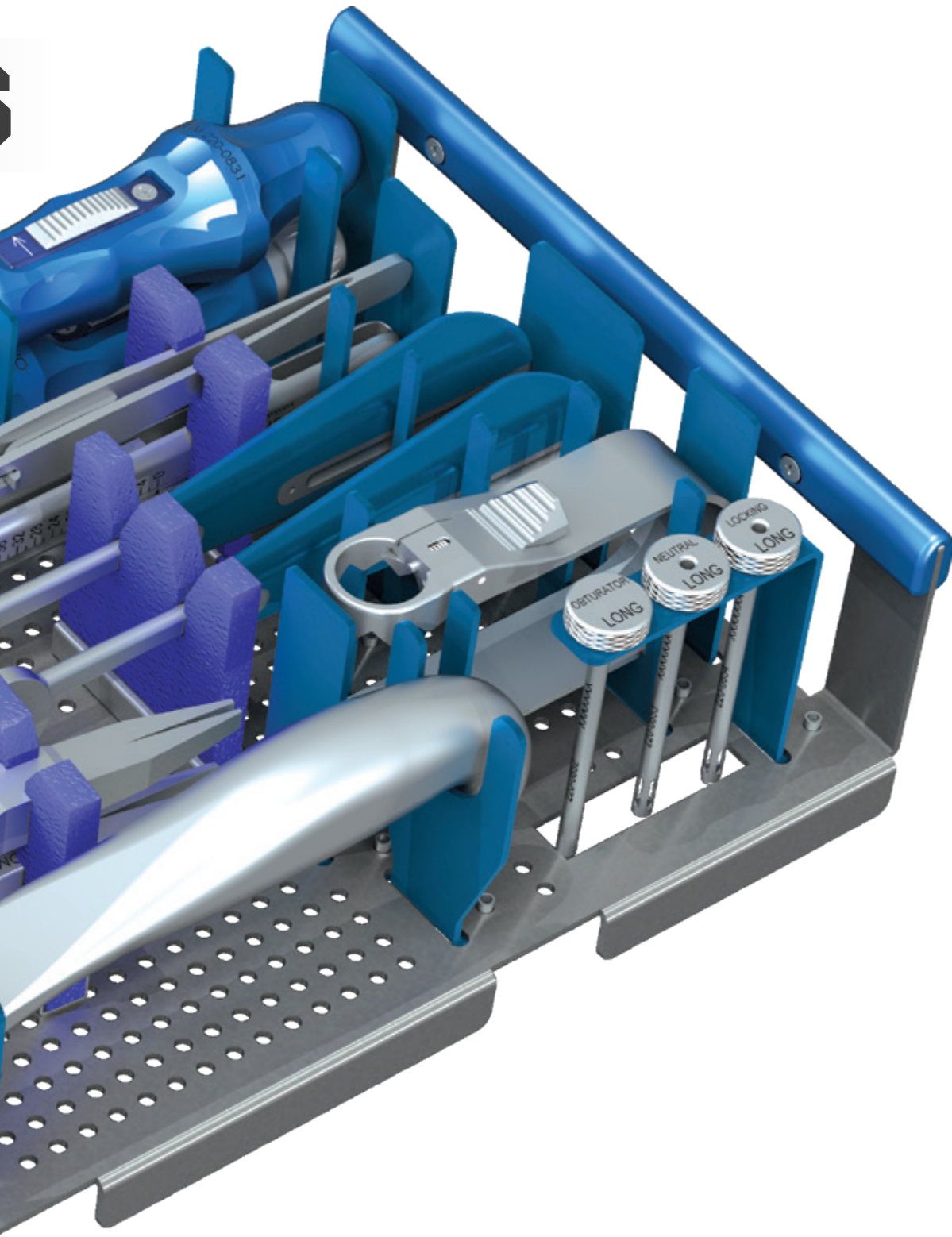

GENERAL INSTRUMENTS

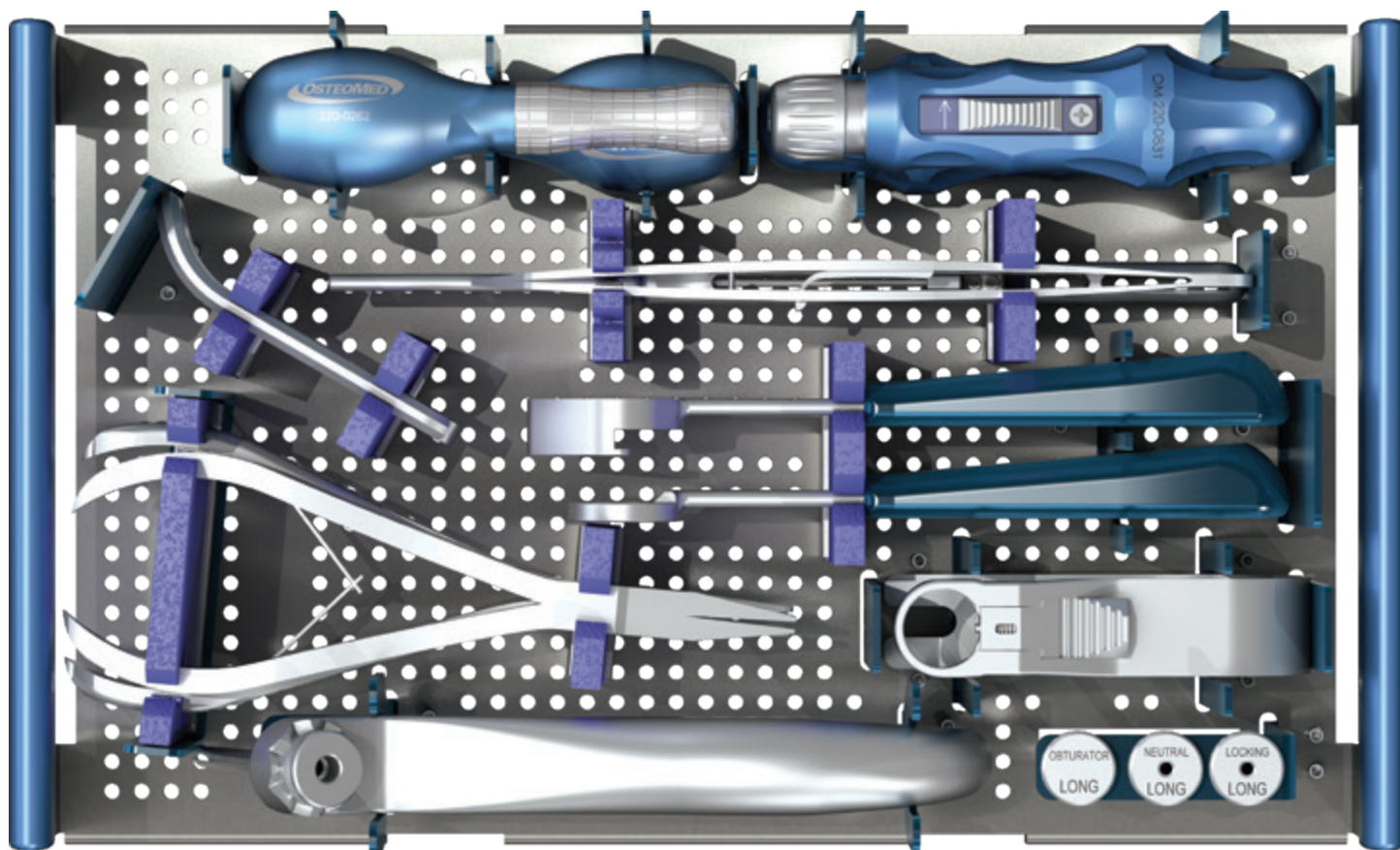

220-0801-02 General Instrument Tray, ICON



220-0027 Small grasping forceps

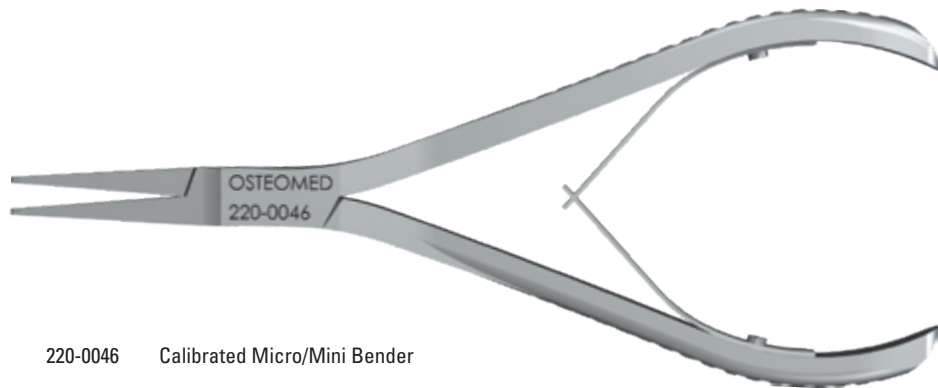

220-0046 Calibrated Micro/Mini Bender

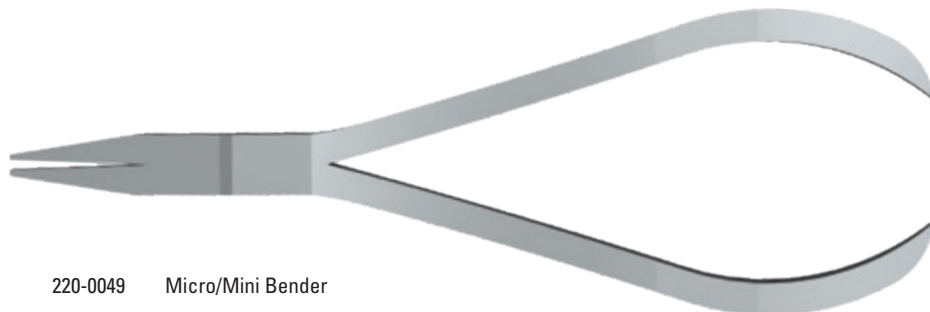

220-0049 Micro/Mini Bender

GENERAL INSTRUMENTS



220-0262 Blue Metal Screwdriver Body



220-0831 Ratchet Driver, Hex Shank, ICON

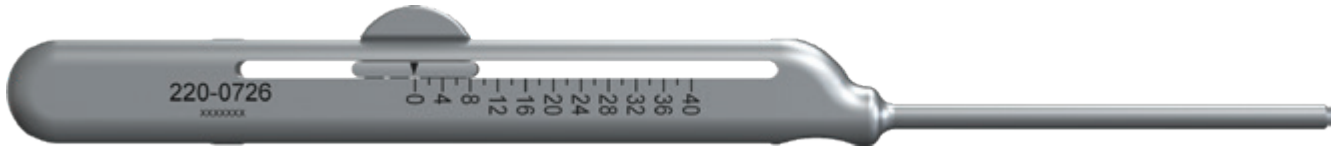

220-0726 Depth Gauge, ICON



220-0851 Trocar Handle, Long, ICON



220-0852 Trocar, Long Cannula, ICON



220-0853 Neutral Drill Guide, Long Cannula, ICON



220-0854 Locking Drill Guide, Long Cannula, ICON



220-0871 U-Shape Cheek Retractor, ICON



220-0872 Blade Cheek Retractor, ICON



220-0882 Assembly, Round Plate Cutter, 2.8mm, ICON



220-0883 Assembly, Flanged Plate Cutter, 2.8mm, ICON



MID-FACE INSTRUMENTS

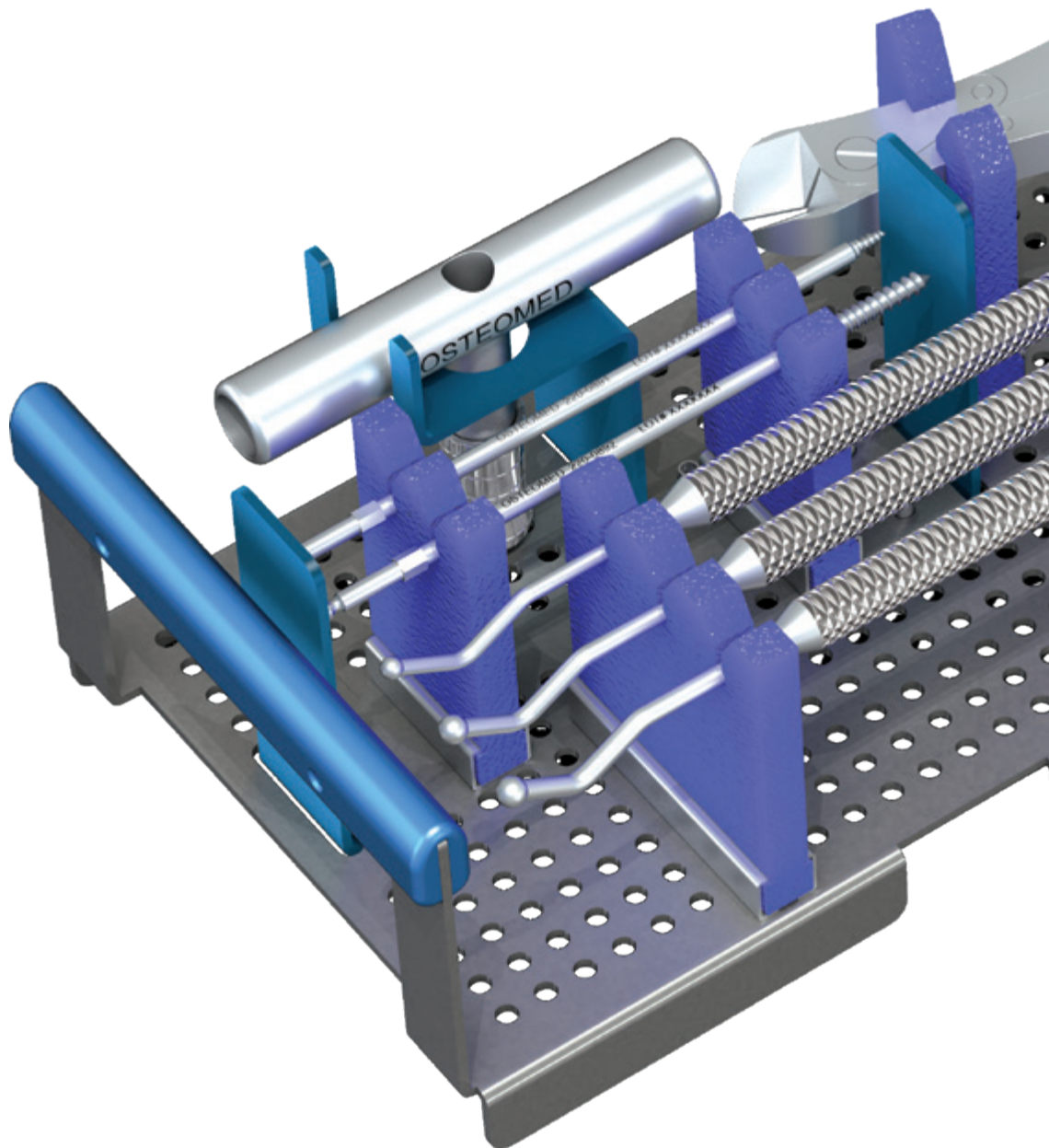

220-0801-04

Mid-Face Instrument Tray, ICON

5

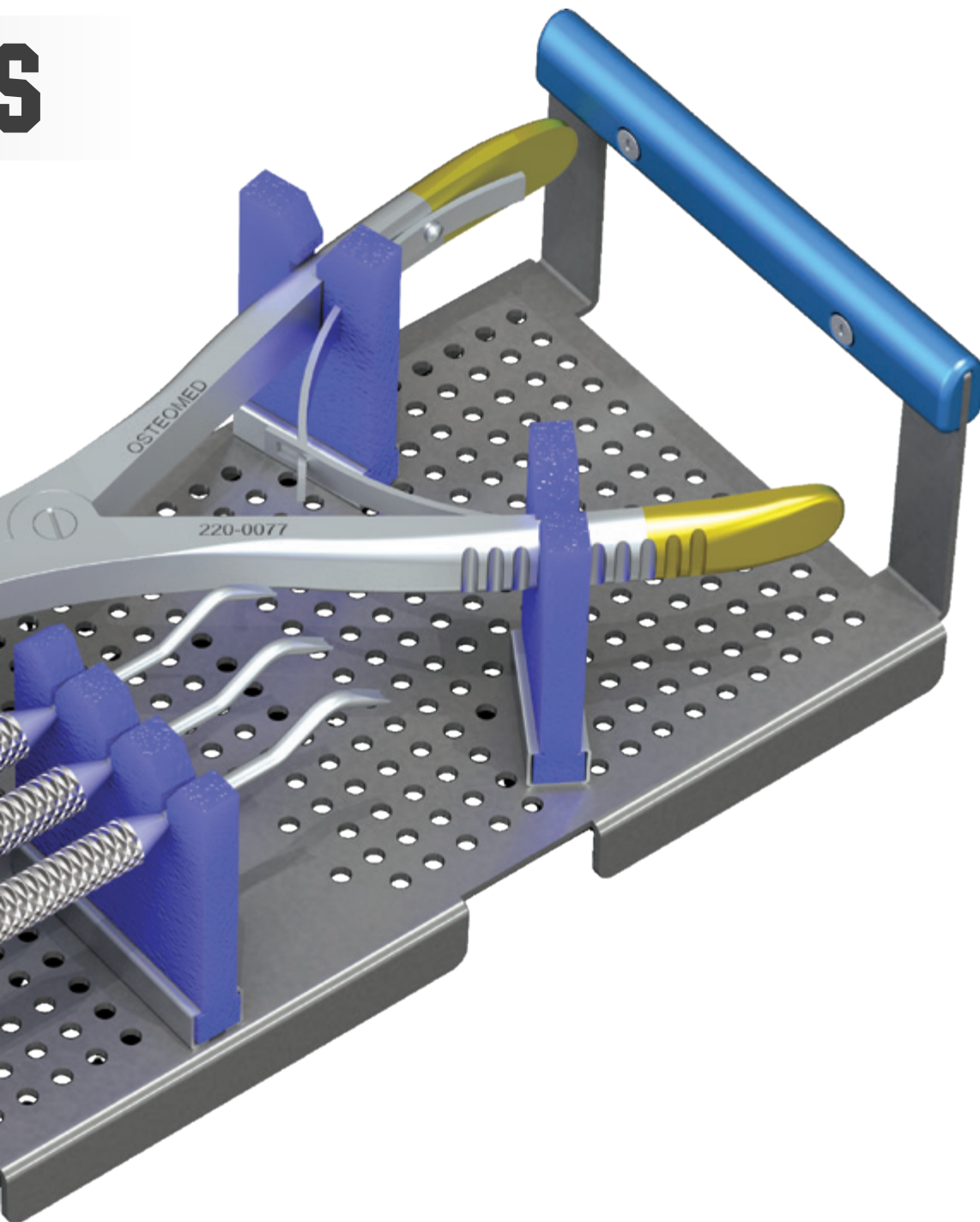

MID-FACE INSTRUMENTS

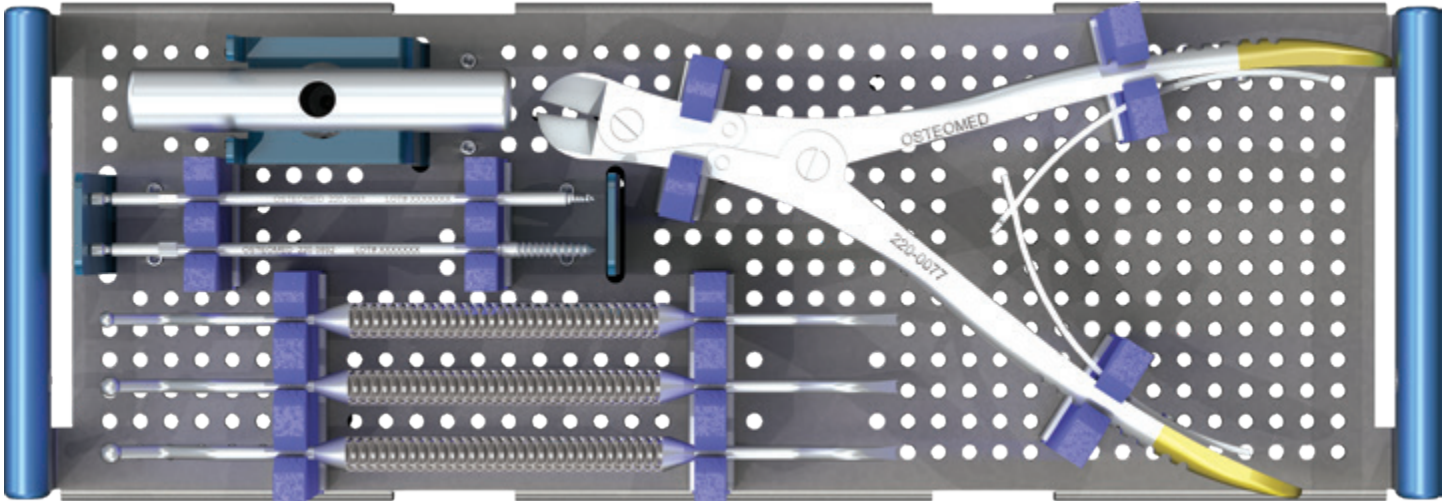

220-0801-04 Mid-Face Instrument Tray, ICON

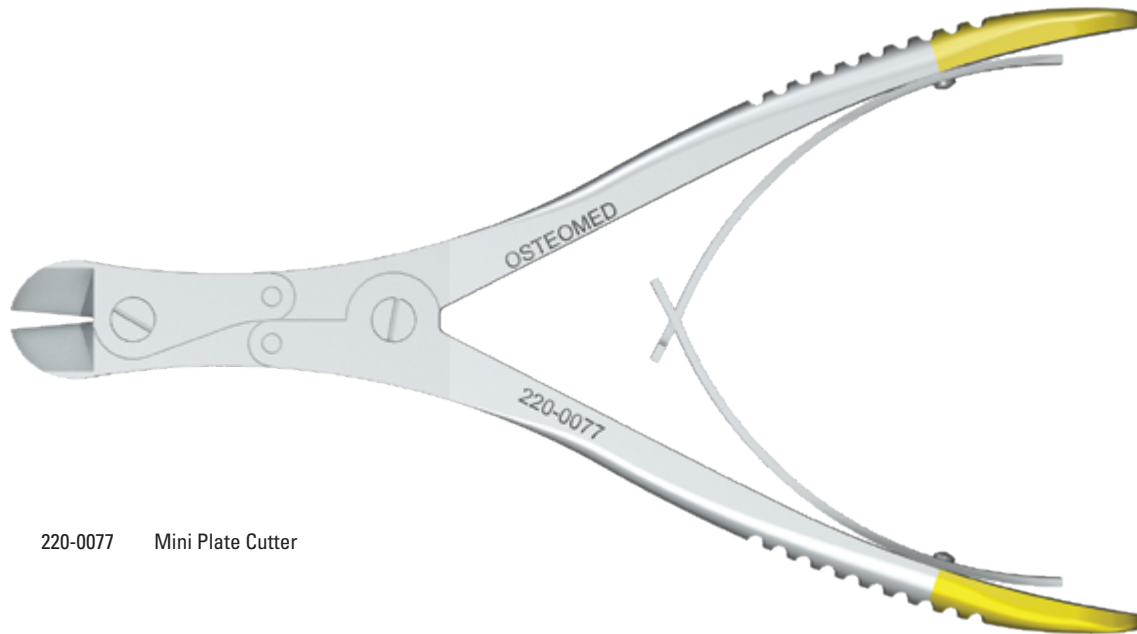

220-0077 Mini Plate Cutter



220-0590 1.2 Plate Holder



220-0591 1.6 Plate Holder



220-0592 2.0 Plate Holder

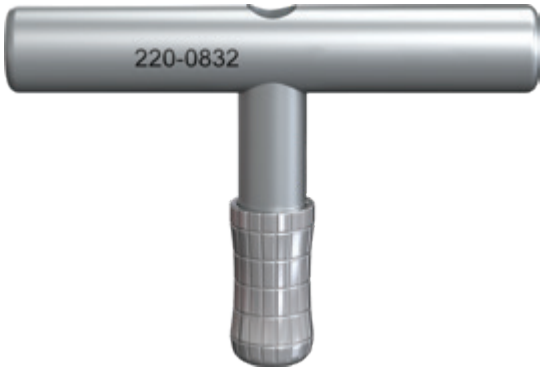

220-0832 T Handle, ICON



220-0891 Bone Manipulation Screw, 2.4mm, ICON



220-0892 Carrol-Girard Instrument, ICON



MANDIBULAR INSTRUMENT



220-0801-03

Mandibular Instrument Tray, ICON

ENTS

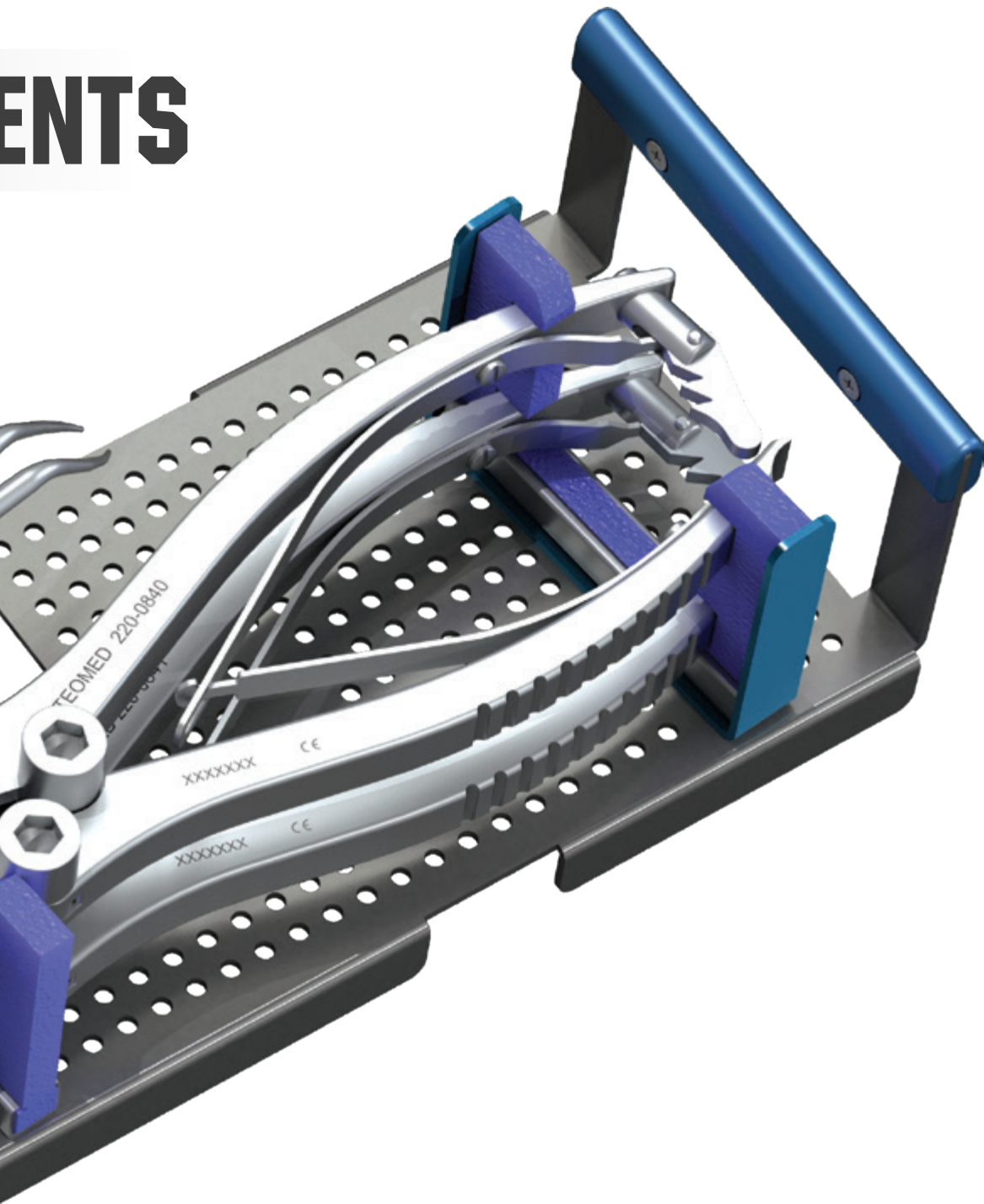

MANDIBULAR INSTRUMENTS



220-0801-03 Mandibular Instrument Tray, ICON

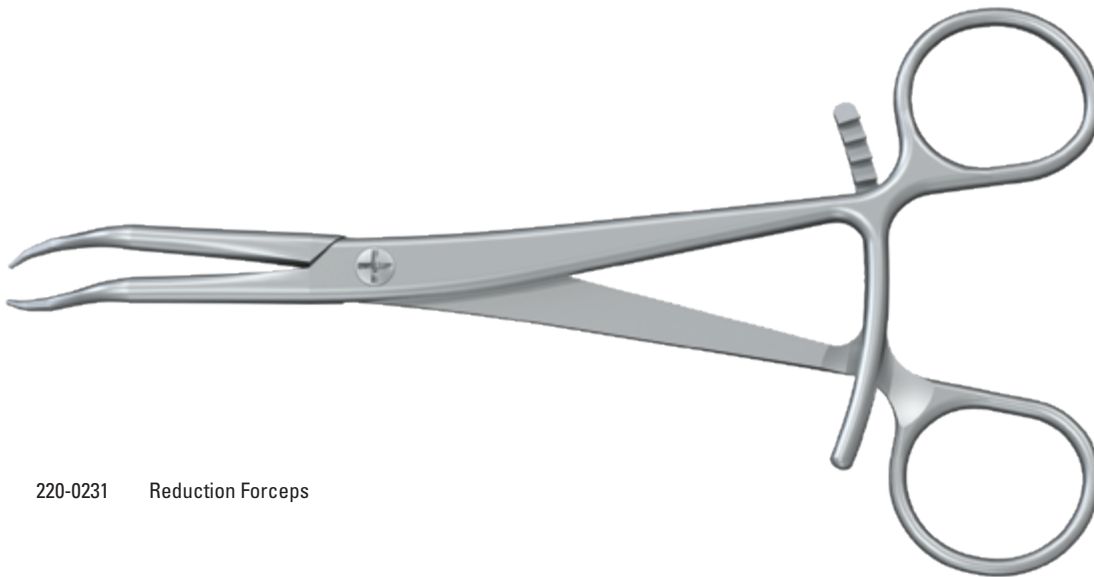

220-0231 Reduction Forceps

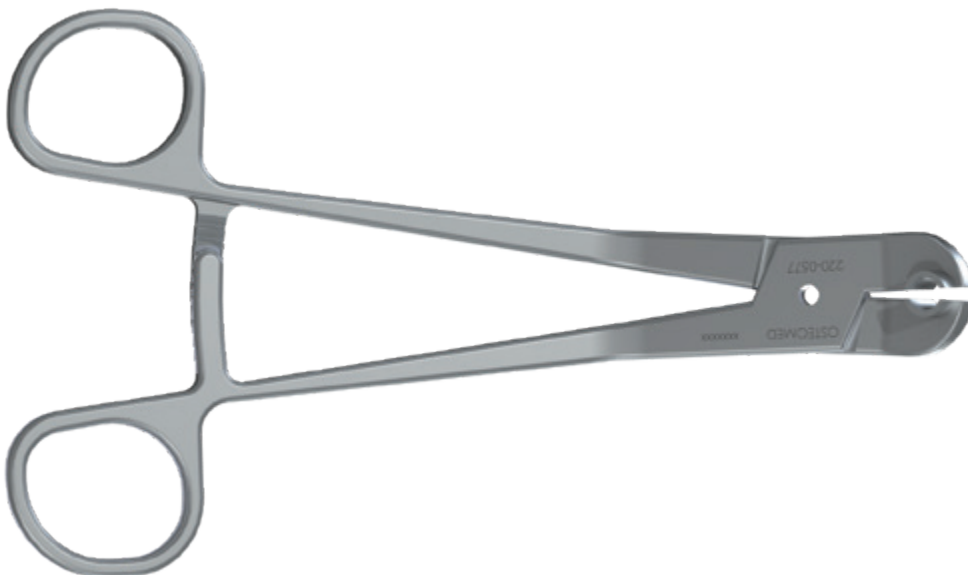

220-0577 Clamping Cheek Retractor

MANDIBULAR INSTRUMENTS

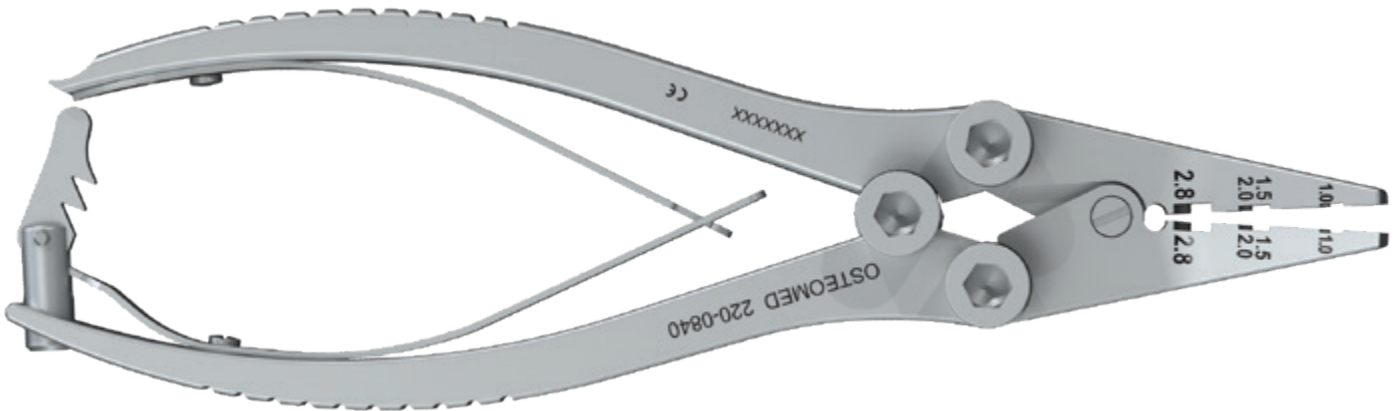

220-0840 Multi Function Bender, ICON

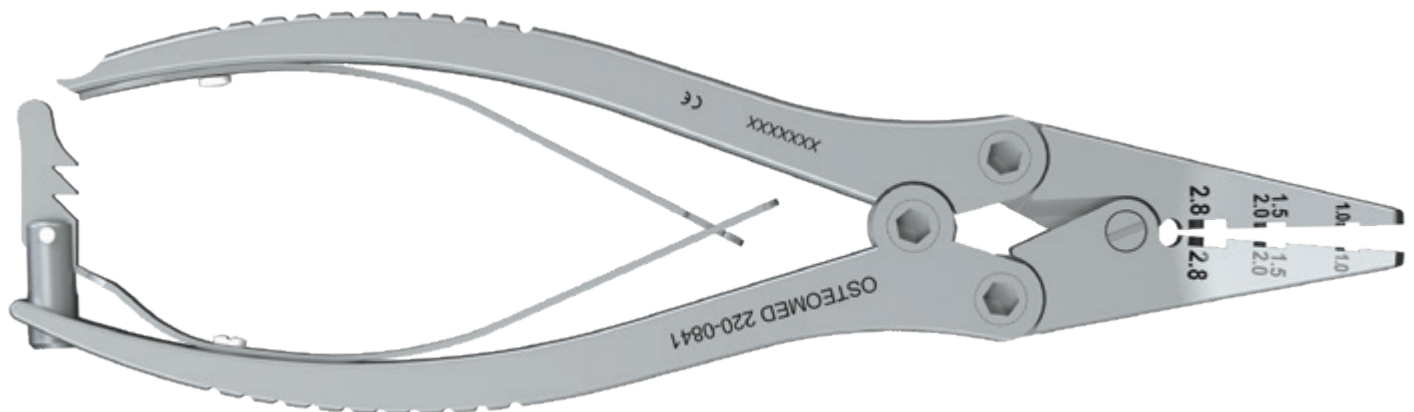

220-0841 Bending Plier, ICON

ADDITIONAL INSTRUMENTS

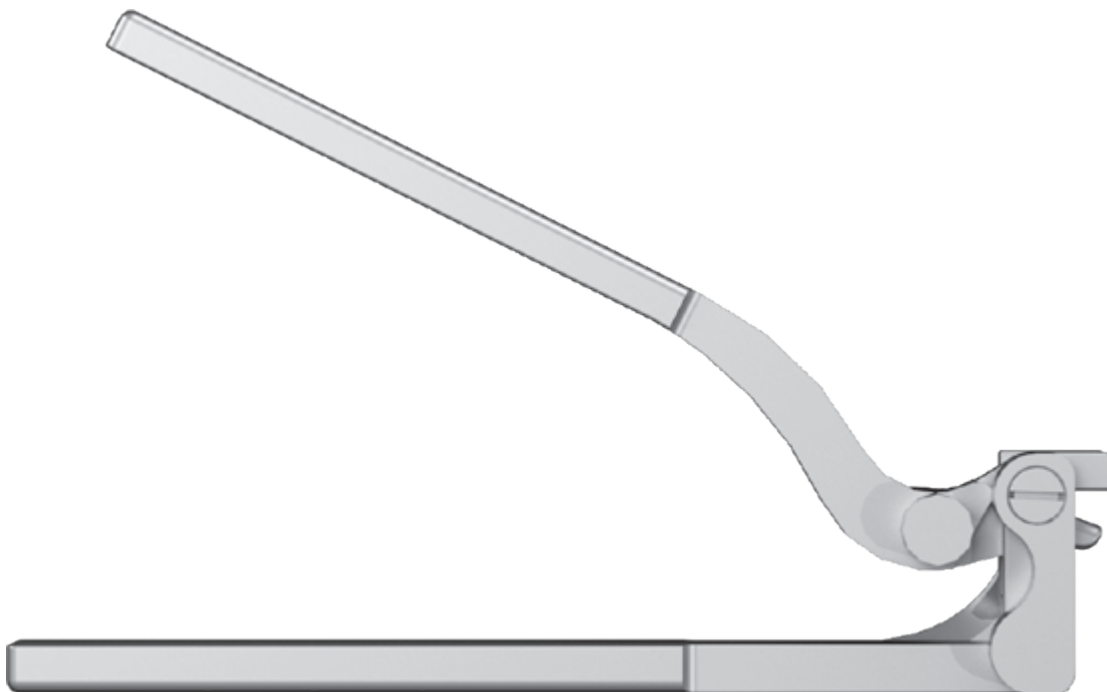

220-0575 Universal Plate Bender *Optional; can be added to the Utility Tray under the instrument racks

INDEX

114-1215	1.2mm Driver Stem, Short, Hex Shank	15		
114-1221	1.2mm Driver Stem, Medium, Hex Shank	15		
114-1233	1.2mm Driver Stem, Long, Hex Shank	15		
114-1615	1.6mm Driver Stem, Short, Hex Shank	29		
114-1621	1.6mm Driver Stem, Medium, Hex Shank	28		
114-1633	1.6mm Driver Stem, Long, Hex Shank	29		
114-2015	2.0mm Driver Stem, Short, Hex Shank	44	59	71
114-2021	2.0mm Driver Stem, Medium, Hex Shank	43	58	70
114-2033	2.0mm Driver Stem, Long, Hex Shank	43	58	70
204-1203	1.2mm x 3mm Standard Screw	14		
204-1204	1.2mm x 4mm Standard Screw	14		
204-1206	1.2mm x 6mm Standard Screw	14		
204-1208	1.2mm x 8mm Standard Screw	14		
204-1210	1.2mm x 10mm Standard Screw	14		
204-1212	1.2mm x 12mm Standard Screw	14		
204-1214	1.2mm x 14mm Standard Screw	14		
204-1504	1.5mm x 4mm Safety Screw	14		
204-1506	1.5mm x 6mm Safety Screw	14		
206-2404	2.4mm x 4mm Screw	56	68	
206-2405	2.4mm x 5mm Screw	56	68	
206-2406	2.4mm x 6mm Screw	56	68	
206-2408	2.4mm x 8mm Screw	56	68	
206-2410	2.4mm x 10mm Screw	56	68	
206-2412	2.4mm x 12mm Screw	56	68	
206-2414	2.4mm x 14mm Screw	56	68	
206-2416	2.4mm x 16mm Screw	56	68	
206-2418	2.4mm x 18mm Screw	56	68	
206-2420	2.4mm x 20mm Screw	56	68	
206-2422	2.4mm x 22mm Screw	56	68	
206-2704	2.7mm x 4mm Safety Screw	56	68	
206-2706	2.7mm x 6mm Safety Screw	56	68	
206-2708	2.7mm x 8mm Safety Screw	56	68	
206-2710	2.7mm x 10mm Safety Screw	56	68	
206-2712	2.7mm x 12mm Safety Screw	56	68	
206-2714	2.7mm x 14mm Safety Screw	56	68	
206-2716	2.7mm x 16mm Safety Screw	56	68	
206-2718	2.7mm x 18mm Safety Screw	56	68	
206-2720	2.7mm x 20mm Safety Screw	56	68	
208-1603	1.6mm x 3mm Standard Screw	27		
208-1604	1.6mm x 4mm Standard Screw	27		
208-1605	1.6mm x 5mm Standard Screw	27		
208-1606	1.6mm x 6mm Standard Screw	27		
208-1608	1.6mm x 8mm Standard Screw	27		
208-1610	1.6mm x 10mm Standard Screw	27		
208-1612	1.6mm x 12mm Standard Screw	27		
208-1614	1.6mm x 14mm Standard Screw	27		
208-1903	1.9mm x 3mm Safety Screw	27		

208-1904	1.9mm x 4mm Safety Screw	27		
208-1905	1.9mm x 5mm Safety Screw	27		
208-1906	1.9mm x 6mm Safety Screw	27		
208-1908	1.9mm x 8mm Safety Screw	27		
208-1910	1.9mm x 10mm Safety Screw	27		
208-1912	1.9mm x 12mm Safety Screw	27		
208-1914	1.9mm x 14mm Safety Screw	27		
209-2008	2.0mm x 8mm MMF AUTO-DRIVE® Screw	42	55	67
209-2011	2.0mm x 11mm MMF AUTO-DRIVE® Screw	42	55	67
210-0006	15mm Right "L" Plate	34		
210-0008	15mm Left "L" Plate	34		
210-0010	18mm Right "L" Plate	35		
210-0012	18mm Left "L" Plate	35		
210-0014	23mm Right "L" Plate	35		
210-0016	23mm Left "L" Plate	35		
210-0018	26mm "Y" Plate	36		
210-0020	15mm Right ZED Plate	36		
210-0022	15mm Left ZED Plate	36		
210-0024	18mm Right ZED Plate	36		
210-0026	18mm Left ZED Plate	36		
210-0030	24mm 4 Hole Straight Plate	36		
210-0032	10 Hole Straight Plate	36		
210-0034	16 Hole Straight Plate	36		
210-0035	16mm "I" Plate	36		
210-0036	22mm "T" Plate	36		
210-0038	18 Hole Straight Plate	32		
210-0040	4mm Chin Plate	33		
210-0041	2mm Chin Plate	33		
210-0042	6mm Chin Plate	33		
210-0043	3mm Chin Plate	34		
210-0044	8mm Chin Plate	34		
210-0046	10mm Chin Plate	37		
210-0048	12mm Chin Plate	37		
210-0052	7mm "X" Plate	37		
210-0062	2.0mm, 5mm Chin Plate	37		
210-0063	2.0mm, 7mm Chin Plate	37		
210-0080	Extended "Y" Plate	37		
210-0081	Extended Right "L" Plate	35		
210-0082	Extended Left "L" Plate	35		
210-0110	7 Hole Curved Plate	32		
210-0206	15mm Right "L" Rigid Plate	37		
210-0208	15mm Left "L" Rigid Plate	37		
210-0210	18mm Right "L" Rigid Plate	37		
210-0212	18mm Left "L" Rigid Plate	37		
210-0214	23mm Right "L" Rigid Plate	38		
210-0216	23mm Left "L" Rigid Plate	38		
210-0218	26mm "Y" Rigid Plate	38		

INDEX

210-0220	15mm Right ZED Rigid Plate	38
210-0222	15mm Left ZED Rigid Plate	38
210-0224	18mm Right ZED Rigid Plate	32
210-0226	18mm Left ZED Rigid Plate	32
210-0230	24mm 4 Hole Straight Rigid Plate	38
210-0231	29mm 4 Hole Straight Rigid Plate	38
210-0232	10 Hole Straight Rigid Plate	38
210-0235	16mm "I" Rigid Plate	38
210-0236	Y Rigid Plate	38
210-0239	Double "Y" Rigid Plate	39
210-0250	2.0mm Right L Plate, 15mm, Rigid	39
210-0251	2.0mm Left L Plate, 15mm, Rigid	39
210-0252	2.0mm Right L Plate, 18mm, Rigid	39
210-0253	2.0mm Left L Plate, 18mm, Rigid	39
210-0254	2.0mm Right L Plate, 23mm, Rigid	39
210-0255	2.0mm Left L Plate, 23mm, Rigid	39
210-1013	12 Hole Straight Plate, 1.0mm Thick	39
210-1021	Mini, 34 Hole Strip	39
210-1022	Mini, 68 Hole Strip, Rigid	40
210-1030	Mini, 4 Hole Straight Plate, 1.0mm	40
210-1031	Mini, 6 Hole Straight Plate, 1.0mm	40
210-1032	Mini, 8 Hole Straight Plate, 1.0mm	40
210-1036	Mini, 16 Hole Straight Plate, 1.0mm	40
210-1037	2.0mm, 4 Hole Straight Rigid Plate	40
210-1038	2.0mm, 12 Hole Double Row Rigid Plate	40
210-1039	2.0mm, 10 Hole Double Row Rigid Plate	40
211-1603	1.6mm x 3mm AUTO-DRIVE® Screw	27
211-1604	1.6mm x 4mm AUTO-DRIVE® Screw	27
211-1605	1.6mm x 5mm AUTO-DRIVE® Screw	27
211-1606	1.6mm x 6mm AUTO-DRIVE® Screw	27
211-1608	1.6mm x 8mm AUTO-DRIVE® Screw	27
212-0030	7 Hole "Y" Plate	9
212-0031	11 Hole "Y" Plate	10
212-0032	"H" Plate	10
212-0034	18 Hole Straight Plate	9
212-0036	12 Hole Curved Plate	9
212-0038	5 Hole Straight Plate	10
212-0039	10 Hole Straight Plate	9
212-0040	2 x 4 Hole Quad Plate	10
212-0041	Short 2 x 4 Hole Quad Plate	11
212-0042	37 x 50mm Mesh Plate	11
212-0044	13mm Left "L" Plate	11
212-0046	13mm Right "L" Plate	11
212-0048	16mm Left "L" Plate	9
212-0050	16mm Right "L" Plate	9
212-0052	19mm "T" Plate	11
212-0068	"X" Plate	11
212-0069	Medium 2 x 4 Hole Quad Plate	11

212-0080	Orbital Plate	11
212-0086	Orbital Floor Plate, Large	11
212-0134	Square Plate	12
212-0136	Extended "X" Plate	12
212-0138	Extended Double "Y" Plate	12
212-1030	Micro 4 Hole Straight Plate	12
212-1032	Micro 8 Hole Straight Plate	12
212-1040	Micro 6 Hole Double "Y" Plate	9
212-1661	1.2mm Orbital Floor Plate, Fan, .2mm Thick	13
212-1662	1.2mm Orbital Floor Plate, Fan, .3mm Thick	10
212-1663	1.2mm Orbital Floor Plate, Fan, .4mm Thick	13
212-1664	1.2mm Orbital Floor Plate, Fan, .5mm Thick	13
212-1671	1.2mm Orbital Floor Plate, Pick, .2mm Thick	13
212-1672	1.2mm Orbital Floor Plate, Pick, .3mm Thick	10
212-1673	1.2mm Orbital Floor Plate, Pick, .4mm Thick	13
212-1674	1.2mm Orbital Floor Plate, Pick, .5mm Thick	13
212-1681	1.2mm Orbital Floor Plate, Preformed, Left, .2mm Thick	13
212-1682	1.2mm Orbital Floor Plate, Preformed, Left, .3mm Thick	13
212-1683	1.2mm Orbital Floor Plate, Preformed, Left, .4mm Thick	13
212-1684	1.2mm Orbital Floor Plate, Preformed, Left, .5mm Thick	13
212-1691	1.2mm Orbital Floor Plate, Preformed, Right, .2mm Thick	13
212-1692	1.2mm Orbital Floor Plate, Preformed, Right, .3mm Thick	13
212-1693	1.2mm Orbital Floor Plate, Preformed, Right, .4mm Thick	13
212-1694	1.2mm Orbital Floor Plate, Preformed, Right, .5mm Thick	13
213-0000	13mm Right "L" Plate	19
213-0001	13mm Left "L" Plate	19
213-0002	15mm Right "L" Plate	19
213-0003	15mm Left "L" Plate	19
213-0004	22mm Right "L" Plate	20
213-0005	22mm Left "L" Plate	20
213-0006	9mm Right ZED Plate	22
213-0007	9mm Left ZED Plate	22
213-0008	11mm Right ZED Plate	20
213-0009	11mm Left ZED Plate	20
213-0010	15mm 5 Hole "Y" Plate	18
213-0011	10 Hole Curved Plate	18
213-0013	4 Hole "I" Plate	22
213-0014	18mm 4 Hole Straight Plate	23
213-0016	12 Hole Straight Plate	23
213-0017	11 Hole Extended "Y" Plate	23
213-0018	1.6mm Rigid Curved Plate, 10 Hole	18
213-0019	1.6mm Rigid Straight Plate, 10 Hole	23
213-0028	1.6mm, L-Plate, Left, 8 Hole	23
213-0031	1.6mm, Straight Plate, 18 Hole	18
213-0040	Right "L" Plate, 6mm, Rigid	23
213-0041	Left "L" Plate, 6mm, Rigid	23
213-0042	Right "L" Plate, 8mm, Rigid	18
213-0043	Left "L" Plate, 8mm, Rigid	18

INDEX

213-0044	Right "L" Plate, 10mm, Rigid	18
213-0045	Left "L" Plate, 10mm, Rigid	18
213-0046	Right "L" Plate, 12mm, Rigid	20
213-0047	Left "L" Plate, 12mm, Rigid	20
213-0048	1.6mm Pre-bent Plate, 2mm step, Left	21
213-0049	1.6mm Pre-bent Plate, 2mm step, Right	21
213-0050	1.6mm Pre-bent Plate, 4mm step, Left	21
213-0051	1.6mm Pre-bent Plate, 4mm step, Right	21
213-0052	1.6mm Pre-bent Plate, 6mm step, Left	22
213-0053	1.6mm Pre-bent Plate, 6mm step, Right	22
213-0054	1.6mm Pre-bent Plate, 8mm step, Left	22
213-0055	1.6mm Pre-bent Plate, 8mm step, Right	22
213-0056	1.6mm Pre-bent Plate, 10mm step, Left	23
213-0057	1.6mm Pre-bent Plate, 10mm step, Right	23
213-0058	1.6mm Pre-bent Plate, 12mm step, Left	24
213-0059	1.6mm Pre-bent Plate, 12mm step, Right	24
213-0062	Buttress Plate Right	22
213-0063	Buttress Plate Left	22
213-0064	1.6mm Buttress Plate, Left, Modified	24
213-0065	1.6mm Buttress Plate, Right, Modified	24
213-0066	1.6mm Modified L Plate 6 Hole Right	24
213-0067	1.6mm Modified L Plate 6 Hole Left	24
213-0082	1.6mm Pre-bent Plate, 5mm step, Left	24
213-0083	1.6mm Pre-bent Plate, 5mm step, Right	24
213-0120	Right "L" Plate, 8mm, Rigid	25
213-0121	Left "L" Plate, 8mm, Rigid	25
213-0200	1.6mm Modified LeFort Plate, Left, 2mm	25
213-0201	1.6mm Modified LeFort Plate, Right, 2mm	25
213-0202	1.6mm Modified LeFort Plate, Left, 3mm	25
213-0203	1.6mm Modified LeFort Plate, Right, 3mm	25
213-1661	1.6mm Orbital Floor Plate, Fan, .2mm Thick	26
213-1663	1.6mm Orbital Floor Plate, Fan, .3mm Thick	26
213-1665	1.6mm Orbital Floor Plate, Fan, .4mm Thick	26
213-1667	1.6mm Orbital Floor Plate, Fan, .5mm Thick	26
213-1671	1.6mm Orbital Floor Plate, Pick, .2mm Thick	26
213-1673	1.6mm Orbital Floor Plate, Pick, .3mm Thick	26
213-1675	1.6mm Orbital Floor Plate, Pick, .4mm Thick	26
213-1677	1.6mm Orbital Floor Plate, Pick, .5mm Thick	26
213-1681	1.6mm Orbital Floor Plate, Preformed, Left, .2mm Thick	26
213-1682	1.6mm Orbital Floor Plate, Preformed, Left, .25mm Thick	26
213-1683	1.6mm Orbital Floor Plate, Preformed, Left, .3mm Thick	26
213-1685	1.6mm Orbital Floor Plate, Preformed, Left, .4mm Thick	26
213-1687	1.6mm Orbital Floor Plate, Preformed, Left, .5mm Thick	26
213-1691	1.6mm Orbital Floor Plate, Preformed, Right, .2mm Thick	26
213-1692	1.6mm Orbital Floor Plate, Preformed, Right, .25mm Thick	26
213-1693	1.6mm Orbital Floor Plate, Preformed, Right, .3mm Thick	26
213-1695	1.6mm Orbital Floor Plate, Preformed, Right, .4mm Thick	26
213-1697	1.6mm Orbital Floor Plate, Preformed, Right, .5mm Thick	26

214-0080	Medium 4 Hole BSSO Plate	34		
214-0082	Long 4 Hole BSSO Plate	34		
214-0083	Long 6 Hole BSSO Plate	40		
214-0084	Short 4 Hole BSSO Plate	34		
214-0086	Short TR BSSO Plate	40		
214-0088	Long TR BSSO Plate	40		
214-0099	Short 6 Hole BSSO Plate	32		
214-0100	Medium 6 Hole BSSO Plate	32		
214-2019	2.0mm Champy Plate, Short, Right	32		
214-2020	2.0mm Champy Plate, Medium, Right	32		
214-2021	2.0mm Champy Plate, Long, Right	33		
214-2022	2.0mm Champy Plate, Short, Left	33		
214-2023	2.0mm Champy Plate, Medium, Left	33		
214-2024	2.0mm Champy Plate, Long, Left	33		
218-0028	Double "Y" Plate	19		
218-0059	2 x 3 Hole Quad Plate	19		
218-0060	2 x 4 Hole Quad Plate	19		
220-0000	0.9 Pilot Drill, J-Latch	15		
220-0001	1.0mm Pilot Drill, J-Latch	15		
220-0002	1.3mm Pilot Drill, J-Latch, 12mm	28		
220-0003	1.6mm Pilot Drill, J-Latch	44	59	71
220-0004	1.6mm Pilot Drill, Long, J-Latch	29	44	59 71
220-0005	2.0mm Pilot Drill, J-Latch, 12mm	58	70	
220-0006	2.0mm Pilot Drill, Long, J-Latch	29	58	70
220-0011	1.0mm Pilot Drill, 4mm Stop, J-Latch	15		
220-0012	1.6mm Pilot Drill, 6mm Stop, J-Latch	44	59	71
220-0013	1.6mm Pilot Drill, 4mm Stop, J-Latch	44	59	71
220-0027	Small grasping forceps	76		
220-0046	Calibrated Micro/Mini Bender	76		
220-0049	Micro/Mini Bender	76		
220-0062	1.3mm Pilot Drill, J-Latch, 16mm	29		
220-0077	Mini Plate Cutter	80		
220-0081	1.2mm Screwdriver Shaft, Long, Manual	15		
220-0089	1.0mm Pilot Drill, 6mm Stop, J-Latch	15		
220-0091	1.3mm Pilot Drill, 4mm Stop, J-Latch	29		
220-0209	1.3mm Pilot Drill, J-Latch, Extended Length	29		
220-0231	Reduction Forceps	84		
220-0262	BLUE METAL SCREWDRIVER BODY	77		
220-0263	Profile Zero, 1.6mm Screwdriver Shaft, Manual	28		
220-0318	0.9mm Pilot Drill, 3mm Stop, J-Latch	15		
220-0319	0.9mm Pilot Drill, 4mm Stop, J-Latch	15		
220-0320	0.9mm Pilot Drill, 5mm Stop, J-Latch	15		
220-0460	1.6mm Pilot Drill, 8mm Stop, J-Latch	43	58	70
220-0461	1.6mm Extended Pilot Drill, 8mm Stop, J-Latch	43	59	71
220-0462	1.6mm Extended Pilot Drill, 6mm Stop, J-Latch	43	58	70
220-0575	Universal Plate Bender	85		
220-0560	2.0mm Pilot Drill, Long, Mandible System, J-Latch	58	70	
220-0561	1.6mm Pilot Drill, Long, Mandible System, J-Latch	43	58	70

INDEX

220-0577	Clamping Cheek Retractor	84		
220-0590	1.2 Plate Holder	80		
220-0591	1.6 Plate Holder	80		
220-0592	2.0 Plate Holder	80		
220-0726	Depth Gauge, ICON	77		
220-0800	ICON Plating Set	6	7	
220-0801-02	General Instrument Tray, ICON	74	75	76
220-0801-03	Mandibular Instrument Tray, ICON	82	83	84
220-0801-04	Mid-Face Instrument Tray, ICON	78	79	80
220-0801-05	Auxiliary Mesh Tray, ICON	72		
220-0801-06	Utility Tray, ICON	72		
220-0802-01	Set ID Tag, OsteoMed Facial Plating System	73		
220-0802-02	Set ID Tag, OsteoMed Facial Trauma System	73		
220-0802-03	Set ID Tag, OsteoMed Mandible Plating System	73		
220-0802-04	Set ID Tag, OsteoMed MidFace Plating System	73		
220-0802-05	Set ID Tag, OsteoMed Orthognathic Plating System	73		
220-0810	1.6mm Plating Module, ICON	16	17	
220-0811	2.0mm Plating Module, ICON	30	31	
220-0812	2.0/2.4mm Angled Locking Plating Module, ICON	46	47	
220-0813	Angled Locking Reconstruction Module, ICON	60	61	
220-0814	1.2mm Plating Module, ICON	8	9	
220-0820	1.6mm Screw Block, ICON	27		
220-0821	2.0mm Screw Block, ICON	41		
220-0822	2.0mm Angled Locking Screw Block, ICON	54	66	
220-0823	2.4mm Angled Locking Screw Block, ICON	56	68	
220-0831	Ratchet Driver, Hex Shank, ICON	77		
220-0832	T Handle, ICON	82		
220-0840	Multi Function Bender, ICON	85		
220-0841	Bending Plier, ICON	85		
220-0851	Trocar Handle, Long, ICON	77		
220-0852	Trocar, Long Cannula, ICON	77		
220-0853	Neutral Drill Guide, Long Cannula, ICON	77		
220-0854	Locking Drill Guide, Long Cannula, ICON	77		
220-0871	U-Shape Cheek Retractor, ICON	77		
220-0872	Blade Cheek Retractor, ICON	77		
220-0882	Assembly, Round Plate Cutter, 2.8mm, ICON	77		
220-0883	Assembly, Flanged Plate Cutter, 2.8mm, ICON	77		
220-0891	Bone Manipulation Screw, 2.4mm, ICON	81		
220-0892	Carroll-Girard Screw, ICON	81		
220-0898	1.6mm ICON Rainbow Drill, Long Cannula, J-Latch	44	59	71
220-0899	2.0mm ICON Rainbow Drill, Long Cannula, J-Latch	59	71	
222-0004	1.1mm Pilot Drill, 4mm Stop, J-Latch	29		
222-0006	1.1mm Pilot Drill, 6mm Stop, J-Latch	29		
231-1000	ICON, 4 Hole BSSO Plate, Locking, Short, 1.0mm Thick	48		
231-1000T	ICON, 4 Hole BSSO Plate, Locking, Short, 1.0mm Thick, TEMPLATE	48		
231-1001	ICON, 4 Hole BSSO Plate, Locking, Medium, 1.0mm Thick	48		
231-1001T	ICON, 4 Hole BSSO Plate, Locking, Medium, 1.0mm Thick, TEMPLATE	48		
231-1002	ICON, 4 Hole BSSO Plate, Locking, Long, 1.0mm Thick	49		

231-1002T	ICON, 4 Hole BSSO Plate, Locking, Long, 1.0mm Thick, TEMPLATE	49
231-1011	ICON, 6 Hole BSSO Plate, Locking, Small, 1.0mm Thick	48
231-1011T	ICON, 6 Hole BSSO Plate, Locking, Small, 1.0mm Thick, TEMPLATE	48
231-1012	ICON, 6 Hole BSSO Plate, Locking, Medium, 1.0mm Thick	48
231-1012T	ICON, 6 Hole BSSO Plate, Locking, Medium, 1.0mm Thick, TEMPLATE	48
231-1021	ICON, 4 Hole Locking Plate, 1.0mm Thick	49
231-1021T	ICON, 4 Hole Locking Plate, 1.0mm Thick, TEMPLATE	49
231-1022	ICON, 6 Hole Straight Plate, Locking, 1.0mm Thick	49
231-1022T	ICON, 6 Hole Straight Plate, Locking, 1.0mm Thick, TEMPLATE	49
231-1023	ICON, 18 Hole Straight Plate, Locking, 1.0mm Thick	49
231-1023T	ICON, 18 Hole Straight Plate, Locking, 1.0mm Thick, TEMPLATE	49
231-1024	ICON, 15 Hole Comminution Plate, Locking, 1.0mm Thick	48
231-1024T	ICON, 15 Hole Comminution Plate, Locking, 1.0mm Thick, TEMPLATE	48
231-1031	ICON, 5 Hole Curved Plate, Locking, 1.0mm Thick	48
231-1031T	ICON, 5 Hole Curved Plate, Locking, 1.0mm Thick, TEMPLATE	48
231-1032	ICON, 7 Hole Curved Plate, Locking, 1.0mm Thick	49
231-1032T	ICON, 7 Hole Curved Plate, Locking, 1.0mm Thick, TEMPLATE	49
231-1033	ICON, 9 Hole Curved Plate, Locking, 1.0mm Thick	49
231-1033T	ICON, 9 Hole Curved Plate, Locking, 1.0mm Thick, TEMPLATE	49
231-1035	ICON, 2x4 Curved Strut Plate, Locking, 1.0mm Thick	49
231-1035T	ICON, 2x4 Curved Strut Plate, Locking, 1.0mm Thick, TEMPLATE	49
231-1036	ICON, 2x8 Curved Strut Plate, Locking 1.0mm Thick	49
231-1036T	ICON, 2x8 Curved Strut Plate, Locking 1.0mm Thick, TEMPLATE	49
231-1041	ICON, 2x2 Locking Plate, 1.0mm Thick	49
231-1041T	ICON, 2x2 Locking Plate, 1.0mm Thick, TEMPLATE	49
231-1042	ICON, 3x3 Locking Plate, 1.0mm Thick	50
231-1042T	ICON, 3x3 Locking Plate, 1.0mm Thick, TEMPLATE	50
231-1051	ICON, Condylar Trauma Plate, 4 Hole, 1.0mm Thick	50
231-1051T	ICON, Condylar Trauma Plate, 4 Hole, 1.0mm Thick, TEMPLATE	50
231-1052	ICON, Condylar Trauma Plate, 5 Hole, 1.0mm Thick	50
231-1052T	ICON, Condylar Trauma Plate, 5 Hole, 1.0mm Thick, TEMPLATE	50
231-1053	ICON, Condylar, Trauma Plate, 6 Hole, Left	50
231-1053T	ICON, Condylar, Trauma Plate, 6 Hole, Left, TEMPLATE	50
231-1054	ICON, Condylar, Trauma Plate, 6 Hole, Right	50
231-1054T	ICON, Condylar, Trauma Plate, 6 Hole, Right, TEMPLATE	50
231-1055	ICON, Mandibular Fan Plate, 1mm Thick	50
231-1055T	ICON, Mandibular Fan Plate, 1mm Thick, TEMPLATE	50
231-1501	ICON, 4 Hole Fracture Plate, Locking, Short, 1.5mm Thick	51
231-1501T	ICON, 4 Hole Fracture Plate, Locking, Short, 1.5mm Thick, TEMPLATE	51
231-1502	ICON, 4 Hole Fracture Plate, LockingMedium, 1.5mm Thick	51
231-1502T	ICON, 4 Hole Fracture Plate, LockingMedium, 1.5mm Thick, TEMPLATE	51
231-1503	ICON, 4 Hole Fracture Plate, Locking, Long, 1.5mm Thick	51
231-1503T	ICON, 4 Hole Fracture Plate, Locking, Long, 1.5mm Thick, TEMPLATE	51
231-1511	ICON, 6 Hole Fracture Plate, Locking, Short, 1.5mm Thick	51
231-1511T	ICON, 6 Hole Fracture Plate, Locking, Short, 1.5mm Thick, TEMPLATE	51
231-1512	ICON, 6 Hole Fracture Plate, Locking, Medium, 1.5mm Thick	51
231-1512T	ICON, 6 Hole Fracture Plate, Locking, Medium, 1.5mm Thick, TEM- PLATE	51

INDEX

231-1513	ICON, 6 Hole Fracture Plate, Locking, Long, 1.5mm Thick	52	
231-1513T	ICON, 6 Hole Fracture Plate, Locking, Long, 1.5mm Thick, TEMPLATE	52	
231-1521	ICON, 8 Hole Comminution Plate, 1.5mm Thick	51	
231-1521T	ICON, 8 Hole Comminution Plate, 1.5mm Thick, TEMPLATE	51	
231-1531	ICON, 2x2 Locking Plate, 1.5mm Thick	52	
231-1531T	ICON, 2x2 Locking Plate, 1.5mm Thick, TEMPLATE	52	
231-1532	ICON, 3x3 Locking Plate, 1.5mm Thick	52	
231-1532T	ICON, 3x3 Locking Plate, 1.5mm Thick, TEMPLATE	52	
231-2001	ICON, 14 Hole Reconstruction Plate, Locking, 2.0mm Thick	53	
231-2001T	ICON, 14 Hole Reconstruction Plate, Locking, 2.0mm Thick, TEMPLATE	53	
231-2011	ICON, 5x16 Hole Reconstruction Plate, Locking, Left, 2.0mm Thick	53	
231-2011T	ICON, 5x16 Hole Reconstruction Plate, Locking, Left, 2.0mm Thick, TEMPLATE	53	
231-2012	ICON, 5x16 Hole Reconstruction Plate, Locking, Right, 2.0mm Thick	53	
231-2012T	ICON, 5x16 Hole Reconstruction Plate, Locking, Right, 2.0mm Thick, TEMPLATE	53	
231-2021	ICON, 5x20x5 Reconstruction Plate, Locking, 2.0mm Thick	52	53
231-2021T	ICON, 5x20x5 Reconstruction Plate, Locking, 2.0mm Thick, TEMPLATE	52	53
231-2022	ICON, 6x24x6 Reconstruction Plate, Locking, 2.0mm Thick	52	53
231-2022T	ICON, 6x24x6 Reconstruction Plate, Locking, 2.0mm Thick, TEMPLATE	52	53
231-2801	ICON, 14 Hole Reconstruction Plate, Locking, 2.8mm Thick	62	
231-2801T	ICON, 14 Hole Reconstruction Plate, Locking, TEMPLATE	62	
231-2802	ICON, 18 Hole Reconstruction Plate, Locking, 2.8mm Thick	62	
231-2802T	ICON, 18 Hole Reconstruction Plate, Locking, TEMPLATE	62	
231-2811	ICON, 4x12 Hole Reconstruction Plate, Locking, Left, 2.8mm Thick	62	
231-2811T	ICON, 4x12 Hole Reconstruction Plate, Locking, Left, TEMPLATE	62	
231-2812	ICON, 4x12 Hole Reconstruction Plate, Locking, Right, 2.8mm Thick	63	
231-2812T	ICON, 4x12 Hole Reconstruction Plate, Locking, Right, TEMPLATE	63	
231-2813	ICON, 5x16 Hole Reconstruction Plate, Locking, Left, 2.8mm Thick	63	
231-2813T	ICON, 5x16 Hole Reconstruction Plate, Locking, Left, TEMPLATE	63	
231-2814	ICON, 5x16 Hole Reconstruction Plate, Locking, Right, 2.8mm Thick	63	
231-2814T	ICON, 5x16 Hole Reconstruction Plate, Locking, Right, TEMPLATE	63	
231-2821	ICON, 5x16x5 Hole Reconstruction Plate, Locking, 2.8mm Thick	64	65
231-2821T	ICON, 5x16x5H Recon Plate, Locking, TEMPLATE	64	65
231-2822	ICON, 5x20x5 Hole Reconstruction Plate, Locking, 2.8mm Thick	64	65
231-2822T	ICON, 5x20x5H Recon Plate, Locking, TEMPLATE	64	65
232-2005	ICON, 2.0 x 5mm Locking Screw, Self-Tapping	55	67
232-2006	ICON, 2.0 x 6mm Locking Screw, Self-Tapping	55	67
232-2008	ICON, 2.0 x 8mm Locking Screw, Self-Tapping	55	67
232-2010	ICON, 2.0 x 10mm Locking Screw, Self-Tapping	55	67
232-2012	ICON, 2.0 x 12mm Locking Screw, Self-Tapping	55	67
232-2014	ICON, 2.0 x 14mm Locking Screw, Self-Tapping	55	67
232-2016	ICON, 2.0 x 16mm Locking Screw, Self-Tapping	55	67
232-2018	ICON, 2.0 x 18mm Locking Screw, Self-Tapping	55	67
232-2020	ICON, 2.0 x 20mm Locking Screw, Self-Tapping	55	67
232-2022	ICON, 2.0 x 22mm Locking Screw, Self-Tapping	55	67
232-2406	ICON, 2.4mm x 6mm Locking Screw, Self-Tapping	57	69
232-2408	ICON, 2.4mm x 8mm Locking Screw, Self-Tapping	57	69

232-2410	ICON, 2.4mm x 10mm Locking Screw, Self-Tapping	57	69	
232-2412	ICON, 2.4mm x 12mm Locking Screw, Self-Tapping	57	69	
232-2414	ICON, 2.4mm x 14mm Locking Screw, Self-Tapping	57	69	
232-2416	ICON, 2.4mm x 16mm Locking Screw, Self-Tapping	57	69	
232-2418	ICON, 2.4mm x 18mm Locking Screw, Self-Tapping	57	69	
232-2420	ICON, 2.4mm x 20mm Locking Screw, Self-Tapping	57	69	
232-2422	ICON, 2.4mm x 22mm Locking Screw, Self-Tapping	57	69	
232-2706	ICON, 2.7mm x 6mm Angled Locking Emergency Screw	57	69	
232-2708	ICON, 2.7mm x 8mm Angled Locking Emergency Screw	57	69	
232-2710	ICON, 2.7mm x 10mm Angled Locking Emergency Screw	57	69	
232-2712	ICON, 2.7mm x 12mm Angled Locking Emergency Screw	57	69	
232-2714	ICON, 2.7mm x 14mm Angled Locking Emergency Screw	57	69	
232-2716	ICON, 2.7mm x 16mm Angled Locking Emergency Screw	57	69	
232-2718	ICON, 2.7mm x 18mm Angled Locking Emergency Screw	57	69	
232-2720	ICON, 2.7mm x 20mm Angled Locking Emergency Screw	57	69	
232-2722	ICON, 2.7mm x 22mm Angled Locking Emergency Screw	57	69	
234-2004	ICON, 2.0 x 4mm Screw, Self-Tapping	42	54	66
234-2005	ICON, 2.0 x 5mm Screw, Self-Tapping	42	54	66
234-2006	ICON, 2.0 x 6mm Screw, Self-Tapping	42	54	66
234-2008	ICON, 2.0 x 8mm Screw, Self-Tapping	42	54	66
234-2010	ICON, 2.0 x 10mm Screw, Self-Tapping	42	54	66
234-2012	ICON, 2.0 x 12mm Screw, Self-Tapping	42	54	66
234-2014	ICON, 2.0 x 14mm Screw, Self-Tapping	42	54	66
234-2016	ICON, 2.0 x 16mm Screw, Self-Tapping	42	54	66
234-2018	ICON, 2.0 x 18mm Screw, Self-Tapping	42	54	66
234-2020	ICON, 2.0 x 20mm Screw, Self-Tapping	42	54	66
234-2022	ICON, 2.0 x 22mm Screw, Self-Tapping	42	54	66
234-2024	ICON, 2.0 x 24mm Screw, Self-Tapping	42	54	66
234-2304	ICON, 2.3 x 4mm Emergency Screw	42	54	66
234-2305	ICON, 2.3 x 5mm Emergency Screw	42	54	66
234-2306	ICON, 2.3 x 6mm Emergency Screw	42	54	66
234-2308	ICON, 2.3 x 8mm Emergency Screw	42	54	66
234-2310	ICON, 2.3 x 10mm Emergency Screw	42	54	66
234-2312	ICON, 2.3 x 12mm Emergency Screw	42	54	66
234-2314	ICON, 2.3 x 14mm Emergency Screw	42	54	66
234-2316	ICON, 2.3 x 16mm Emergency Screw	42	54	66
234-2318	ICON, 2.3 x 18mm Emergency Screw	42	54	66
234-2320	ICON, 2.3 x 20mm Emergency Screw	42	54	66
234-2322	ICON, 2.3 x 22mm Emergency Screw	42	54	66
234-2324	ICON, 2.3 x 24mm Emergency Screw	42	54	66
235-2004	ICON, 2.0 x 4mm AutoDrive Screw	41		
235-2005	ICON, 2.0 x 5mm AutoDrive Screw	41		
235-2006	ICON, 2.0 x 6mm AutoDrive Screw	41		
235-2008	ICON, 2.0 x 8mm AutoDrive Screw	41		
250-0050	1.3mm Pilot Drill, 6mm Stop, J-Latch	28		
299-2008	ICON, 2.0mm MMF SCREW, 8MM	42	55	67
299-2011	ICON, 2.0mm MMF SCREW, 11MM	42	55	67



FACIAL PLATING SYSTEM

OSTEOMED

3885 Arapaho Rd.
Addison, TX 75001

Customer Service: 800.456.7779

Outside the U.S.: 001.972.677.4600

Fax: 800.390.2620

Fax Outside the U.S.: 001.972.677.4709

E-mail: customer.service@osteomed.com

www.osteomed.com



A COLSON ASSOCIATE

P/N 030-1897 Rev.B