

EXTREMILOCK™

Foot Plating System

Surgical Technique Guide

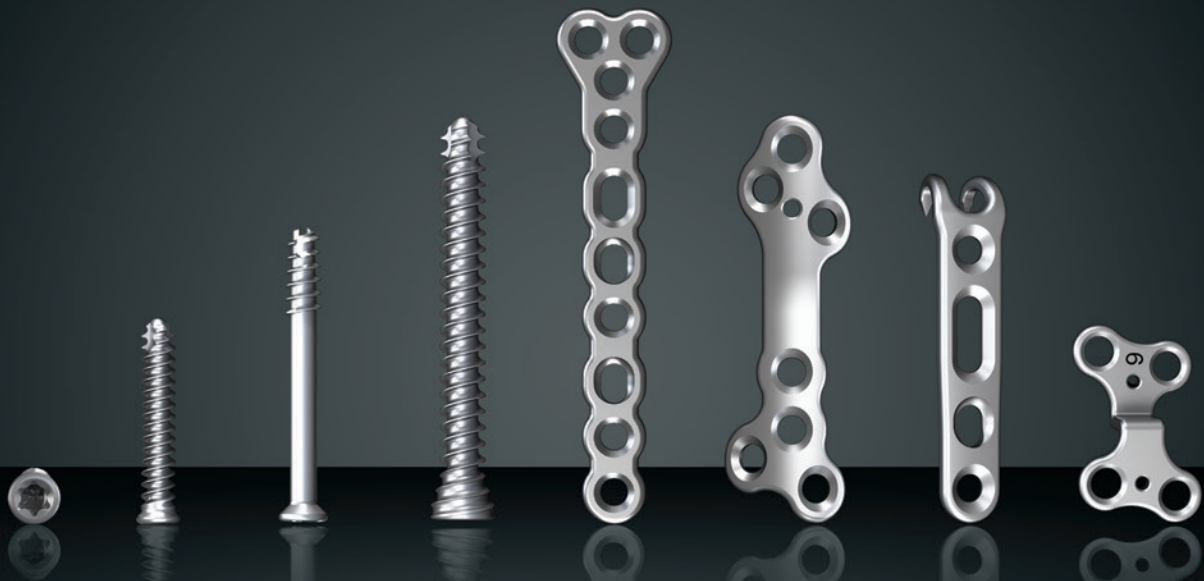
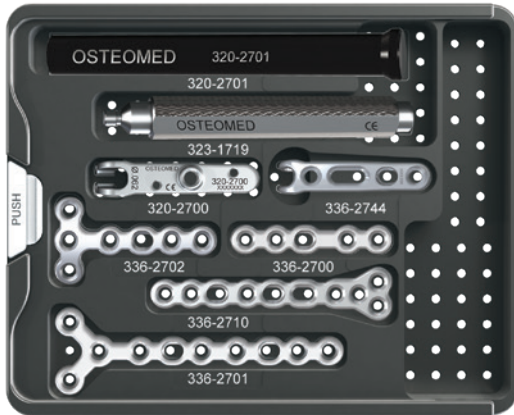

Table of Contents

Organizer Blocks	4-11
Fracture/Fusion Plate and Instrument Module	4
Lapidus Plate Module	4
Wedge Plate and Instrument Module	5
Midfoot/Hindfoot Plate Module	5
1st MTP Fusion Plate and Instrument Module	6
Calcaneal Trauma Plate and Instrument Module	7
2.7/3.0mm Screw Module	8
3.5/4.0mm Screw Module	9
3.0/4.0mm Cannulated Screw Module	10
General Instruments	11
Plating General Technique	12
Screw Preparation and Insertion Technique	13-14
Cannulated Lag Screw Technique	15-16
Plating 1st MTP Arthrodesis	17-20
Plating Base Opening Wedge	21
Plating Base Closing Wedge	22
Plating Lapidus	23-24
Plating 5th Metatarsal Fracture	25-26
Plating Calcaneal Fracture (Lateral Extensile Approach)	27
Plating Calcaneal Fracture (Sinus Tarsi Approach)	28
Plating Evans	29
Plating Calcaneal Slide	30

Organizer Blocks

Fracture/Fusion Plate and Instrument Module



320-2901 Fracture Plates and Instrument Module

2.7mm Plates

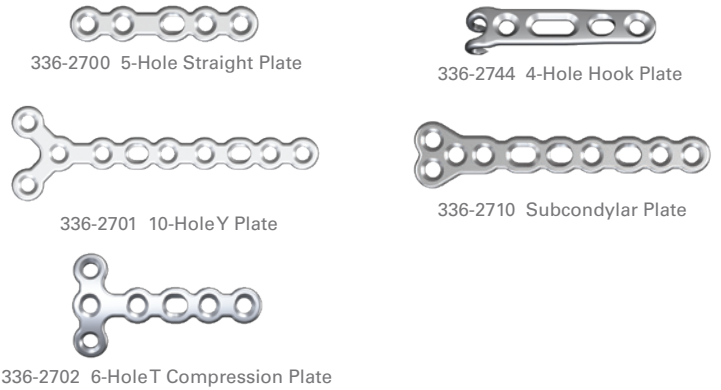

Instruments

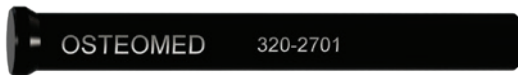

320-2701 Hook Impactor



320-2700 Hook Drill Guide



323-1719 FPS™ Drill Guide Handle

Lapidus Plate Module

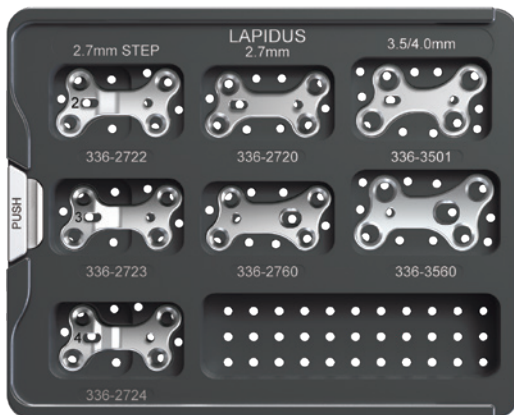

320-2902 Lapidus Plate Module

Plates

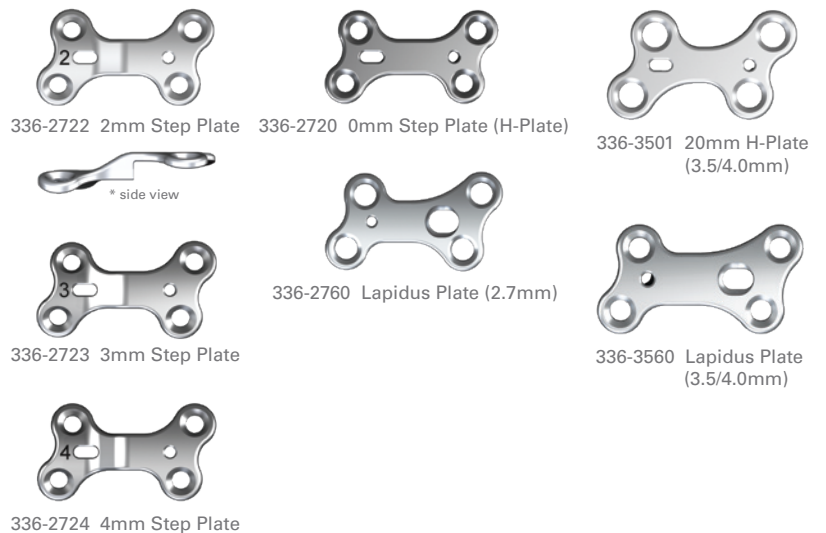

Organizer Blocks

Wedge Plate and Instrument Module



320-2903 Wedge Plate and Instrument Module

2.7mm Plates



336-2730 0mm Wedge Plate
(Closing Wedge)



336-2733 3mm Wedge Plate



* side view



336-2734 4mm Wedge Plate



336-2735 5mm Wedge Plate

Instrument



320-2802 Opening Wedge Clamp

Midfoot/Hindfoot Plate Module

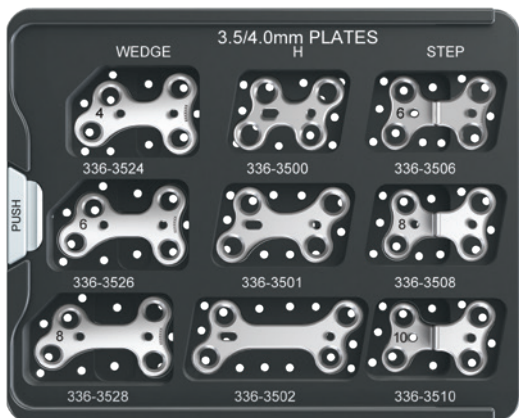

320-2905 Midfoot/Hindfoot Plate Module

3.5/4.0mm Plates



336-3524 4mm Wedge Plate



336-3500 15mm H-Plate



336-3506 6mm Step Plate



336-3526 6mm Wedge Plate



336-3501 20mm H-Plate



336-3508 8mm Step Plate



336-3528 8mm Wedge Plate



336-3502 30mm H-Plate



336-3510 10mm Step Plate

Organizer Blocks

1st MTP Fusion Plate and Instrument Module

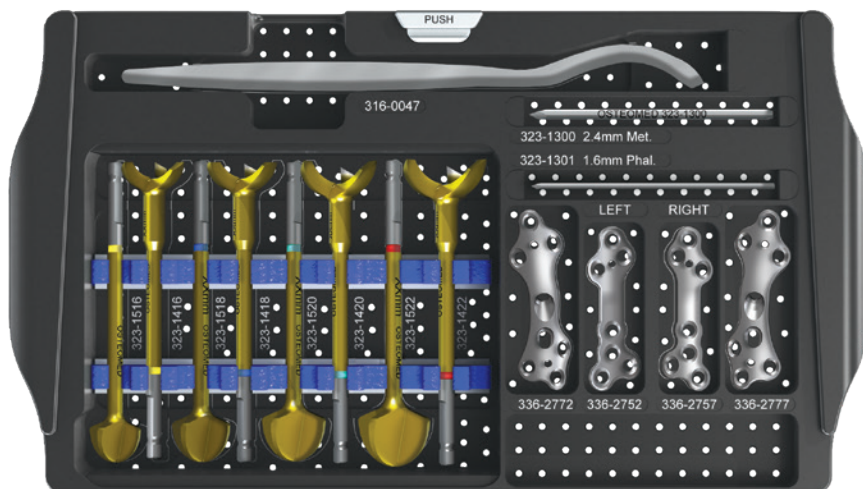

320-2904 1st MTP Fusion Plate and Instrument Module

Instruments

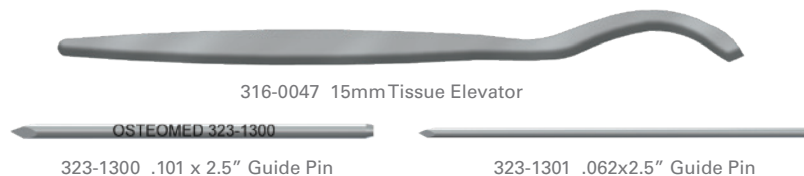

2.7mm Plates



336-2752 1st MTP Fusion Plate (Left - 10°)



336-2757 1st MTP Fusion Plate (Right - 10°)



336-2772 1st MTP Transfixation Fusion Plate (Left - 10°)



336-2777 1st MTP Transfixation Fusion Plate (Right - 10°)

Reamers



323-1416 16mm Cannulated Metatarsal Reamer



323-1516 16mm Cannulated Phalanx Reamer



323-1418 18mm Cannulated Metatarsal Reamer



323-1518 18mm Cannulated Phalanx Reamer



323-1420 20mm Cannulated Metatarsal Reamer



323-1520 20mm Cannulated Phalanx Reamer



323-1422 22mm Cannulated Metatarsal Reamer



323-1522 22mm Cannulated Phalanx Reamer

Organizer Blocks

Calcaneal Trauma Plate and Instrument Module

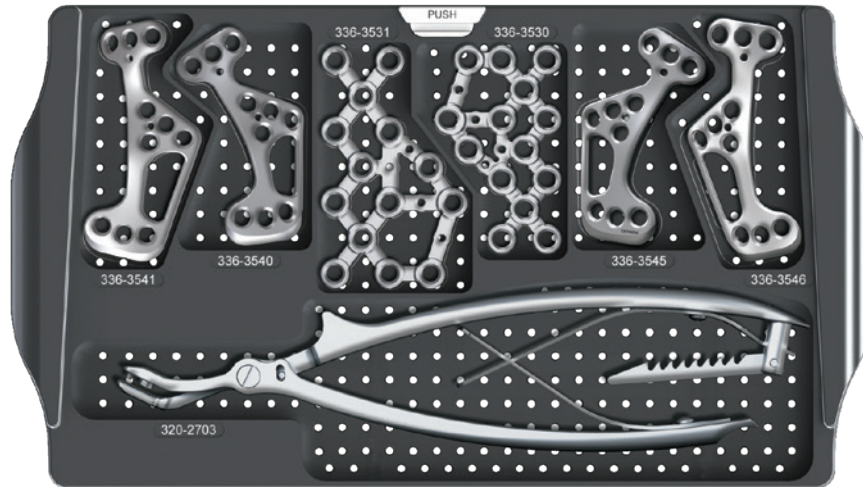

320-2906 Calcaneal Trauma Plate and Instrument Module

3.5/4.0mm Plates



336-3540 58mm MI Calcaneal Plate (Left)



336-3545 58mm MI Calcaneal Plate (Right)



336-3530 56mm Calcaneal Mesh Plate



336-3541 65mm MI Calcaneal Plate (Left)



336-3546 65mm MI Calcaneal Plate (Right)



336-3531 65mm Calcaneal Mesh Plate

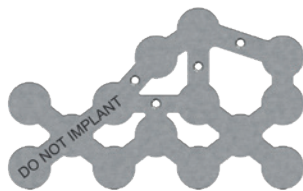

336-3530-T 56mm Calcaneal Mesh Plate, Template

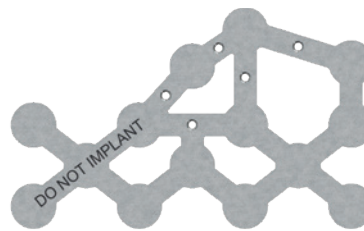

336-3531-T 65mm Calcaneal Mesh Plate, Template

Instrument

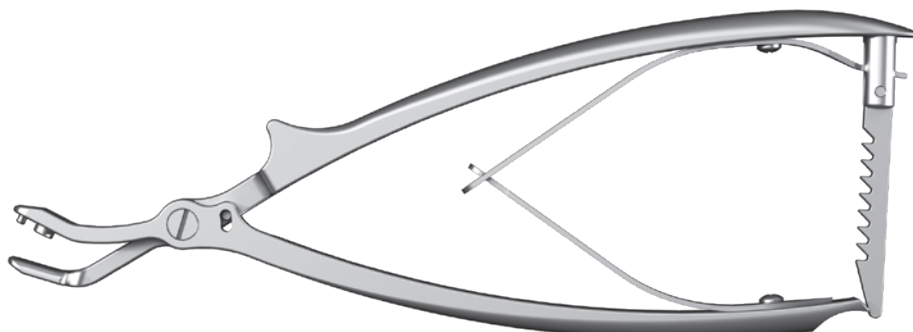

320-2703 MIC Plate Inserter

Organizer Blocks

2.7/3.0mm Screw Module

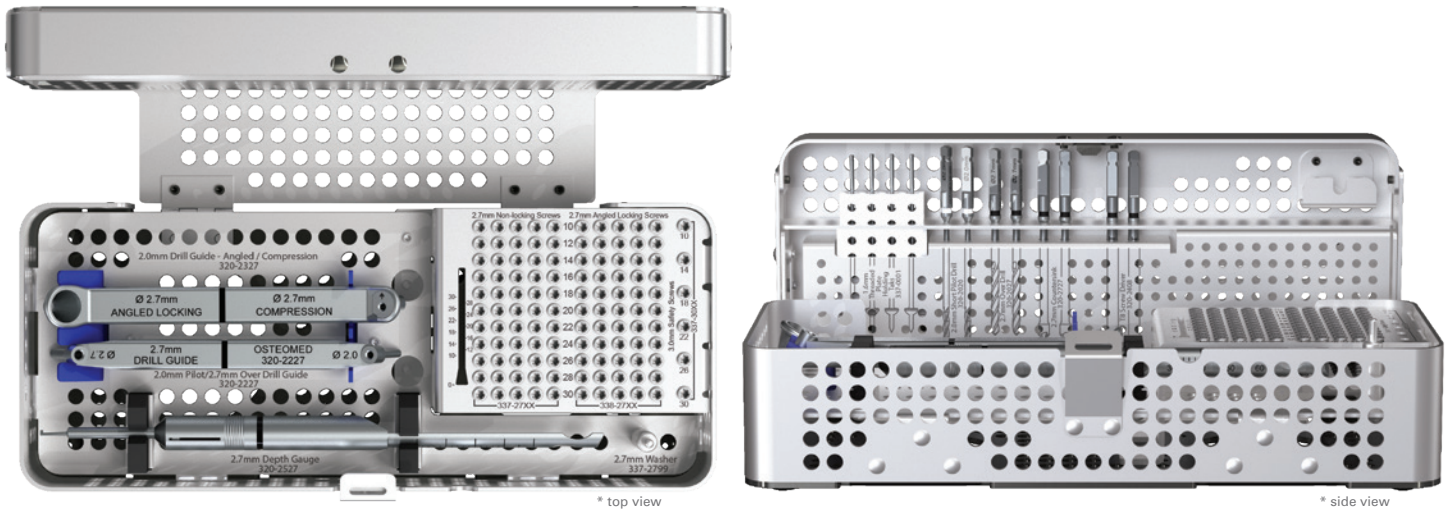

320-2907 2.7/3.0mm Screw Module

Screws



337-27xx 2.7mm x 10mm - 30mm Double-Lead Non-Locking Screw, T8



338-27xx 2.7mm x 10mm - 30mm Double-Lead Locking Screw, T8



337-30xx 3.0mm x 10mm - 30mm Safety Screw, T8

Instruments



320-2227 2.0mm Pilot/2.7mm Over Drill Guide



320-2327 2.7mm Angled Locking/Compression Drill Guide



320-2527 2.7mm Depth Gauge



337-2799 2.7mm Washer



337-0001 1.6mm Threaded Holding TAK



320-2408 T8 Screw Driver



320-2020 2.0mm Short Pilot Drill



320-2727 2.7mm Countersink



320-2027 2.7mm Over Drill

Organizer Blocks

3.5/4.0mm Screw Module

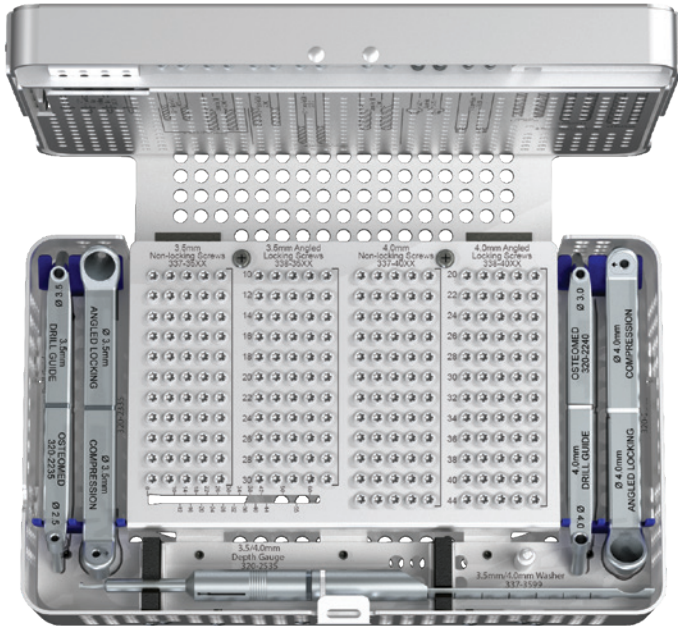

320-2908 3.5/4.0mm Screw Module

* top view

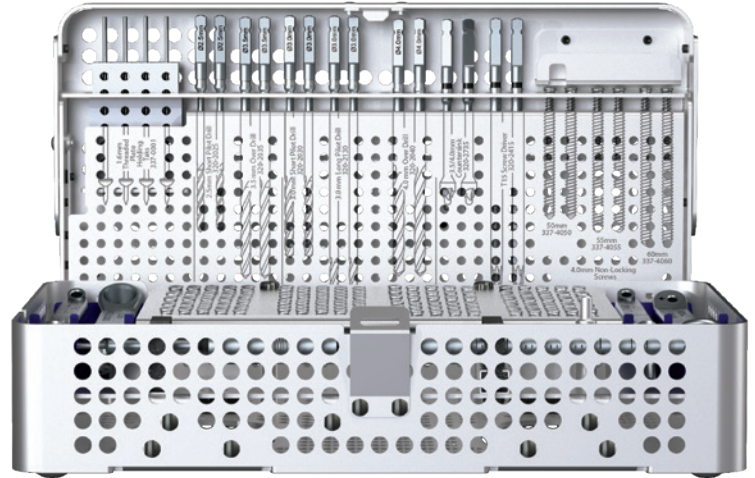

* side view

Screws



337-35xx 3.5mm x 10mm - 30mm Double-Lead Non-Locking Screw, T15



337-40xx 4.0mm x 20mm - 60mm Double-Lead Non-Locking Screw, T15



338-35xx 3.5mm x 10mm - 30mm Double-Lead Locking Screw, T15



338-40xx 4.0mm x 20mm - 44mm Double-Lead Locking Screw, T15

Instruments



320-2235 2.5mm Pilot/3.5mm Over Drill Guide



320-2240 3.0mm Pilot/4.0mm Over Drill Guide



320-2535 3.5/4.0mm Depth Gauge



337-0001 1.6mm Threaded Holding TAK



320-2025 2.5mm Short Pilot Drill



320-2035 3.5mm Over Drill



320-2735 3.5/4.0mm Countersink



320-2335 3.5mm Angled Locking/Compression Drill Guide



320-2340 4.0mm Angled Locking/Compression Drill Guide



337-3599 3.5/4.0mm Washer



320-2030 3.0mm Short Pilot Drill



320-2130 3.0mm Long Pilot Drill



320-2040 4.0mm Over Drill



320-2415 T15 Screw Driver

Organizer Blocks

3.0/4.0mm Cannulated Screw Module

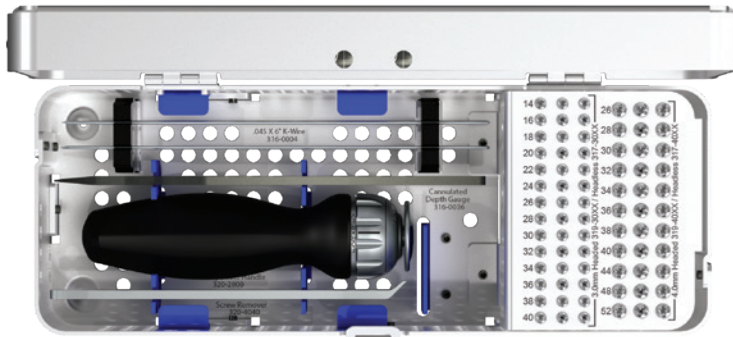

320-2909 3.0/4.0mm Cannulated Screw Module

* top view



Screws



319-30xx 3.0mm x 14mm - 40mm Cannulated Lag Screw



317-30xx 3.0mm x 14mm - 40mm Headless Cannulated Screw



319-40xx 4.0mm x 26mm - 52mm Cannulated Lag Screw



317-40xx 4.0mm x 28mm - 52mm Headless Cannulated Screw

Instruments



320-2800 Ratcheting Driver Handle

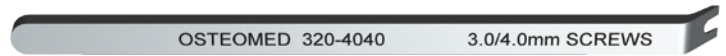

OSTEOMED 320-4040 3.0/4.0mm SCREWS
320-4040 3.0/4.0mm Screw Remover



316-0004 .045 x 6" K-Wire



316-0036 Cannulated Depth Gauge 4"/16"



316-0015 2.3mm Cannulated Drill, Quick Release



316-0427 2.3mm Cannulated Drill, Quick Release



316-0201 3.0/4.0mm Cannulated Countersink, Quick Release



316-0232 3.0/4.0mm Cannulated Driver, Long, Quick Release



316-0233 3.0/4.0mm Cannulated Driver, Short, Quick Release



316-0321 2.4mm, Proximal Cortex, Quick Release



316-0314 3.0/4.0mm Headless Tri-lobe Driver, Cannulated, Short, Quick Release



316-0315 3.0/4.0mm Headless Tri-lobe Driver, Cannulated, Long, Quick Release

Soft Tissue Instrument Tray

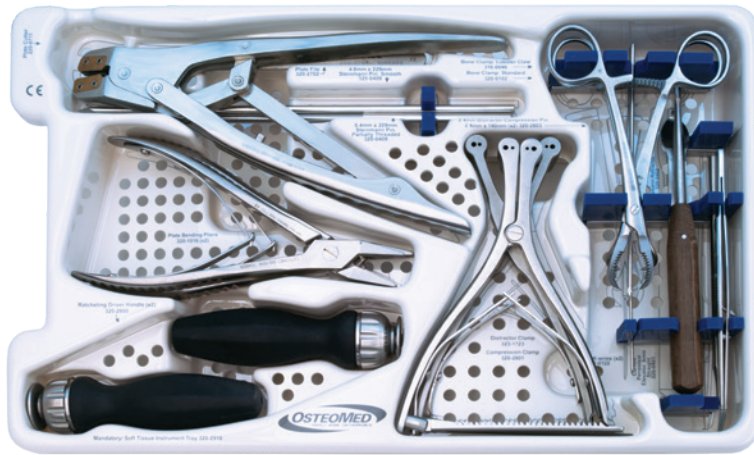

320-2910 Mandatory / Soft Tissue Instrument Tray

320-0402 Hohmann Retractor, 6" w/ 15mm Blade

320-1024 Sharp Hook

320-0401 Periosteal Elevator, 7.25" w/ 6mm Straight



320-0102 Bone Clamp



316-0046 Bone Clamp, Curved Lobster Claw

320-0408 4.0mm x 228mm Steinmann Pin, Smooth

320-0409 4.0mm x 228mm Steinmann Pin, Partially Threaded

321-0122 .062 x 7.25" K-Wires

320-2803 2.4mm x 140mm Distractor Compression Pin

320-2702 Plate File



220-0711 Plate Cutter

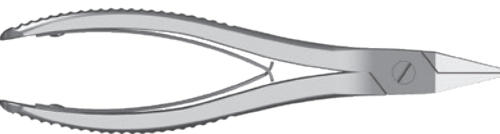

320-1016 Plate Bending Pliers

220-0027 Forceps



320-2800 Ratcheting Driver Handle

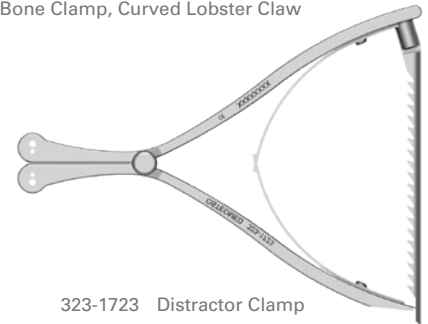

323-1723 Distractor Clamp

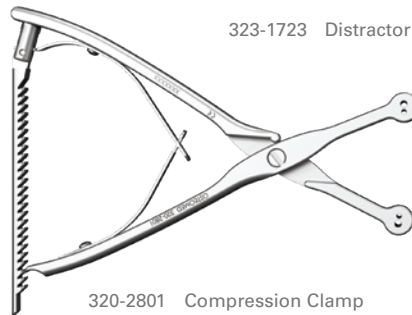

320-2801 Compression Clamp



320-2900 ExtremiLOCK Foot System

Plating General Technique

Preparation

Expose and reduce fracture or osteotomy site

Plate Preparation and Positioning

Select Plate

Select appropriate plate size and configuration.

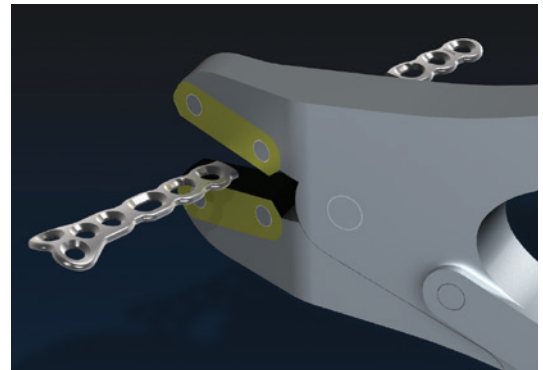

Cut Plate

Plates may be cut using the plate cutter.
The file may be used to blunt any sharp edges.

Note: Do not cut 4 Hole "H" style plates, 1st MTP Arthrodesis plates, 4 Hole Hook plate and MIC Plates.

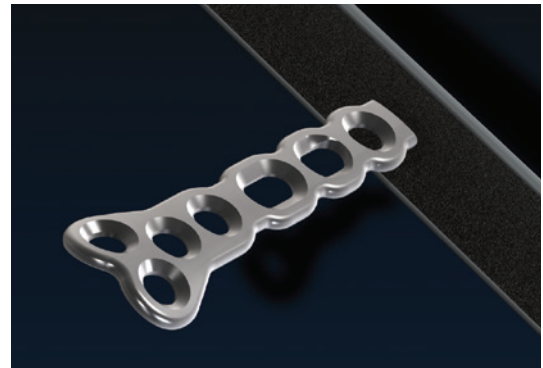

Contour Plate

Plates are precontoured to anatomically fit bone. If further contouring is necessary, plate benders may be used.

Position Plate

Position plate over fracture or osteotomy.
Use plate holding TAKs for temporary fixation during procedure.

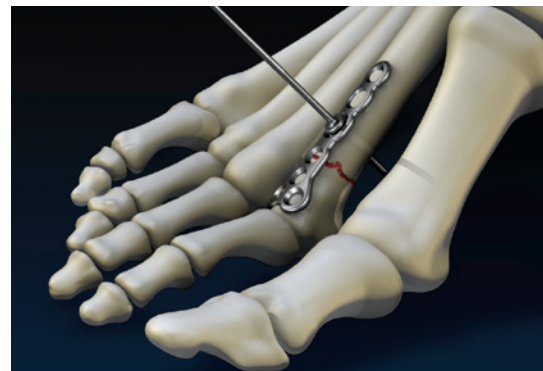

Screw Preparation and Insertion Technique

Determine Desired Screw Type

Double-Lead Locking, Double-Lead Non-Locking, or Cannulated Screws

All circular plate screw holes can accept either a locking or a non-locking screw. Oblong plate screw holes are used for providing compression across a fracture or fusion site and must be used with a non-locking screw. Cannulated screws may be used outside the plate.

The following steps are for Double-Lead Locking & Double-Lead Non-Locking screws

Drill

Double-Lead Locking Screws

Select the appropriate size angled locking/compression drill guide. Insert the cone-shaped drill guide into the desired plate hole ensuring the guide is firmly against the plate hole. The cone will ensure the drill remains within the 40° angled locking screw range ($\pm 20^\circ$ from center).

Double-Lead Non-Locking Screws

Select the appropriate size pilot/overdrill guide. Insert the pilot drill side into the desired plate hole ensuring the guide is firmly against the plate hole.

Drill a pilot hole using the appropriate pilot drill size.

Measure

Use the depth gauge to measure for the correct screw length.

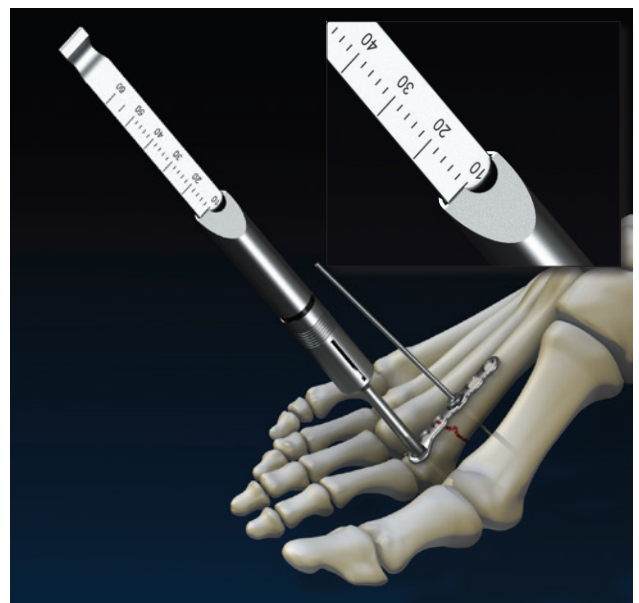
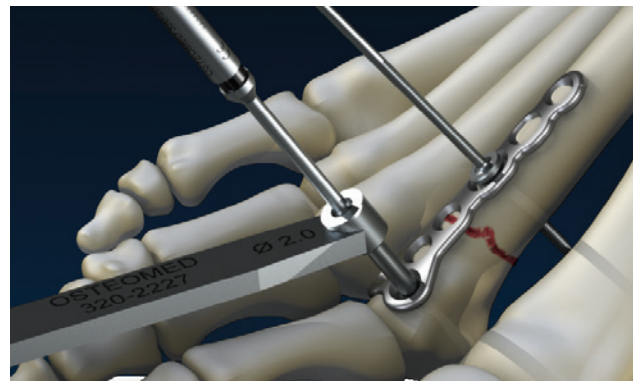

Screw Preparation and Insertion Technique

Screw Insertion

Select & Insert

Select the desired screw diameter and length. Verify the screw length with the gauge on the block. Insert screw manually using a self-retaining screwdriver shaft until the screw head is seated into the plate. Do not overtighten the screw. Fluoroscopy is recommended during screw insertion to ensure correct length and angle.

Locking screws can lock/unlock up to 3 times in a single screw hole.

Remaining Screw Holes

Repeat screw preparation and insertion technique until all necessary holes are filled.

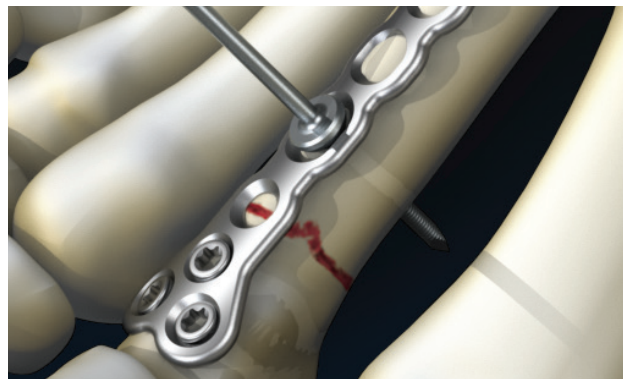

Compression Hole Technique

Fixate plate

Fixate plate on opposite side of the compression hole using locking or non-locking screws

Position Compression Drill Guide

Place drill guide in compression hole. The arrow will be pointing toward fracture/fusion site to drill eccentrically.

NOTE: Turning the drill guide and pointing the arrow away from the fracture/fusion site will allow for placement of a neutral screw.

Drill

Measure

Insert Screw

Only insert a non-locking screw into a compression hole.

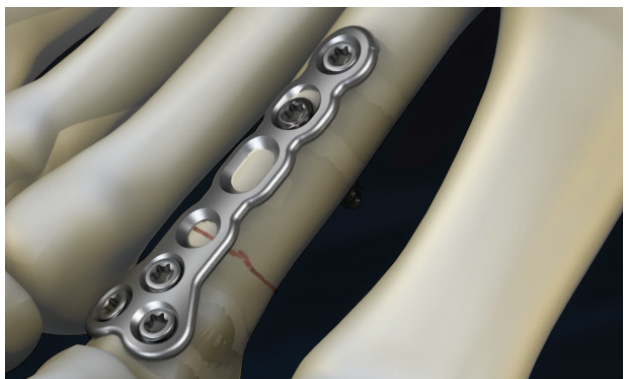

Cannulated Lag Screw Technique

Expose and reduce fracture/fusion site.

Insert a K-wire to the appropriate depth under fluoroscopy.

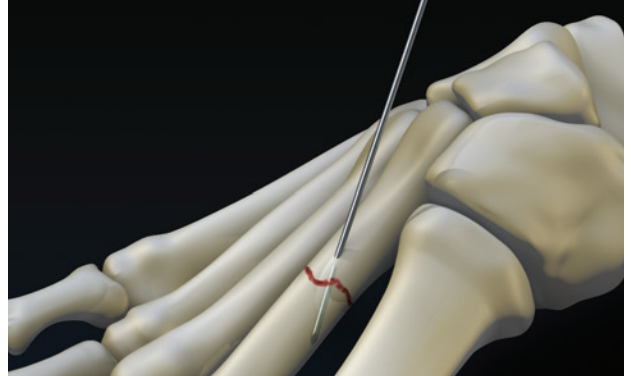

Slide the cannulated depth gauge over the K-wire until the tip bottoms out on bone; the end of the K-wire will indicate the screw length required. Subtract appropriately for any anticipated interfragmentary compression resulting from screw insertion.

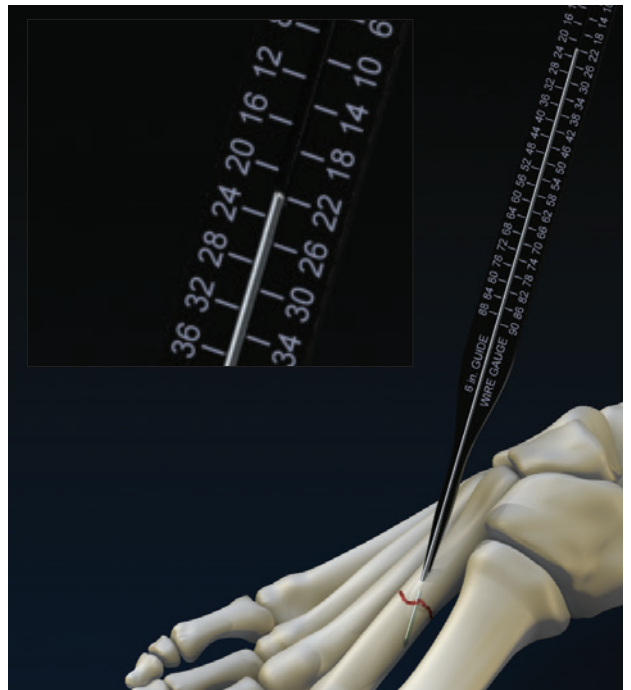

ExtremiFix cannulated screws are self drilling and self tapping, but drilling is recommended in cases of dense bone. If drilling is desired or necessary, drill a pilot hole using the appropriate size cannulated drill.



Cannulated Lag Screw Technique (cont.)

If necessary or desired, use the countersink to create a recess in the bone to reduce screw head prominence and soft tissue irritation. Additionally, for headless screws, the proximal cortex drill is recommended to create a pilot hole for the trailing end of the screw.

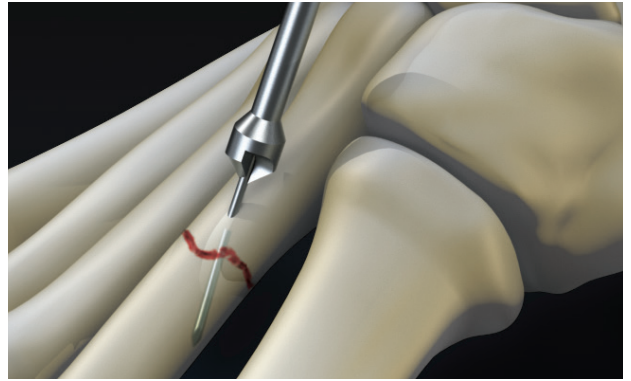

Select the appropriate screw diameter and length. Verify the screw length with the gauge on the block.

Place the screw over the K-wire and use the cannulated driver to implant the screw until the screw is fully seated.

Remove and discard the K-wire.

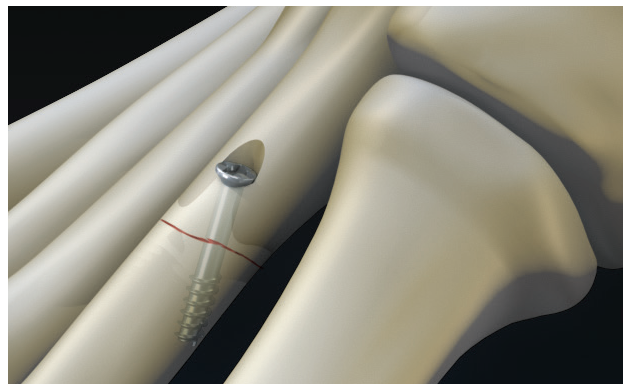

Plating 1st MTP Arthrodesis

Surgical Approach

Make a dorsomedial incision from the middle of the first metatarsal extending to the proximal phalanx of the hallux, medial to the extensor hallucis longus tendon. Incise and release the joint capsule exposing the base of the proximal phalanx and metatarsal head.

Metatarsal and Phalangeal Preparation

Plantar flex the hallux and insert the .101" guide pin into the center of the metatarsal canal. Select the appropriate metatarsal reamer and slide over the guide pin. Start with a larger size reamer and downsize if necessary and ream the metatarsal until bleeding subchondral bone becomes visible taking care not to remove too much bone.

Remove guide pin.

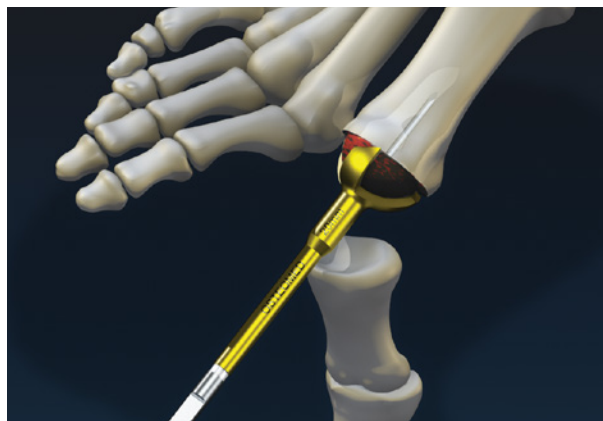

Insert the .062" guide pin into the center of the phalanx. Select the appropriate phalangeal reamer and slide over the guide pin. Start with the smaller size and work up matching the same radius size used on the metatarsal. Ream the phalanx until bleeding subchondral bone becomes visible taking care not to remove too much bone, causing shortening.

Remove guide pin.



Plating 1st MTP Arthrodesis (Cont.)

Fusion Plate Technique

The 1st MTP Fusion plate has 10° of dorsiflexion correction and can accept locking and non-locking screws.

Plate Positioning and Compression

Place the plate over the fusion site. Temporarily fixate the plate using TAKs or K-wires.

Position the phalanx and metatarsal appropriately for fixation. Insert a .045" K-wire medially, either distal to proximal or proximal to distal, through the 1st MTP joint. Insert a cannulated screw following the cannulated lag screw technique.

Insert Screws

For final plate fixation, insert the appropriate sized screws using the screw preparation and insertion technique.

Remove any TAKs or K-wires.



Plating 1st MTP Arthrodesis (Cont.)

Transfixation Plate Technique

Transfixation plate technology allows for a screw to cross through the joint and into the plantar aspect of the opposing bone in the joint resisting plantar gapping through normal gait. The plate and transfixation screw combination results in a stronger biomechanical structure for fusion. The transfixation 1st MTP plate has 10° of dorsiflexion and 10° of valgus correction and can accept locking and non-locking screws. The transfixation screw hole can accept a Double-Lead non-locking screw or a 3.0mm cannulated lag screw.

Plate Positioning and Compression using Compression Hole

Temporarily fixate the plate over the joint using K-wires or Taks. A cheilectomy may be necessary creating a flat surface for the plate.

Fixate the distal screws on the phalanx using the screw preparation and insertion technique.



Insert a screw in the compression hole following the compression hole technique. Remove all temporary fixation prior to final seating of the compression screw.

Fixate remaining proximal screws.



Insert a 2.7mm Double-Lead Non-Locking screw into the Transfixation hole. The screw should purchase as much of the plantar phalanx in order to prevent plantar distraction through normal gait.

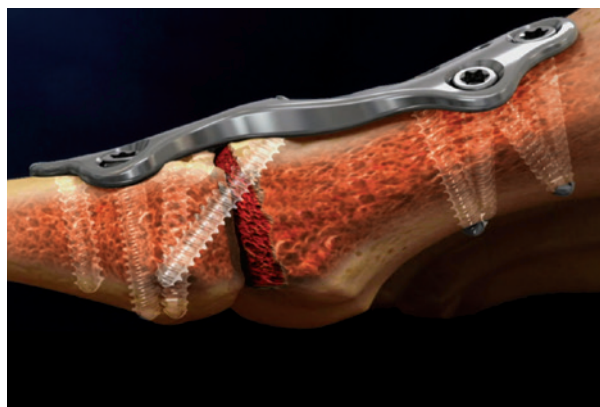

Plating 1st MTP Arthrodesis (Cont.)

Transfixation Plate Technique

Plate Positioning and Compression via Transfixation Hole

Temporarily fixate the plate over the joint using K-wires or TAKs. A cheilectomy may be necessary creating a flat surface for the plate.

Insert a k-wire into the transfixation hole to ensure positioning of lag screw through the MTP joint.

Fixate the distal screws on the phalanx using the screw preparation and insertion technique.



Insert a 3.0mm cannulated lag screw into the transfixation hole following the cannulated lag screw technique.

Fixate remaining proximal screws on the metatarsal. A screw may be inserted into the compression hole in the neutral position for additional fixation.



Plating Base Opening Wedge

Surgical Approach

Make a dorso-medial approach on the proximal 1st metatarsal, distal to the 1st tarsometatarsal (TMT) joint.

Osteotomy

Create a medial to lateral osteotomy approximately 1.5cm distal to the TMT joint leaving the lateral wall intact. Open the osteotomy using osteotomes or the opening wedge distractor; gradually open by turning the instrument knob clockwise. Use fluoroscopy to confirm the desired correction has been achieved.



Plate Selection and Positioning

Select the plate that corresponds to the desired correction. Insert the plate into the osteotomy site with the parallel holes closest to the TMT joint. Temporarily fixate the plate to the metatarsal using plate TAKs.



Insert Screws

For final plate fixation, insert the appropriate sized screws using the screw preparation and insertion technique.

Remove TAKs.

Place bone graft into the osteotomy site.



Plating Base Closing Wedge

Surgical Approach

Make a dorsal approach on the proximal 1st metatarsal, distal to the 1st tarsometatarsal (TMT) joint.

Osteotomy

Create a lateral to medial oblique osteotomy, with a laterally based wedge leaving the medial wall intact. Remove the wedge of resected bone and close the osteotomy. Confirm the IM angle under fluoroscopy. Insert a temporary fixation K-wire from medial to lateral holding the osteotomy in place.



Plate Selection and Positioning

Select the closing base wedge plate and place on the medial wall of the metatarsal with the parallel screw holes closest to the TMT joint. Temporarily fixate the plate to the metatarsal using plate TAKs.

Insert Screws

For final plate fixation, insert the appropriate sized screws using the screw preparation and insertion technique.

Remove TAKs.



Plating Lapidus

Surgical Approach

Make a dorsomedial incision over the 1st tarsometatarsal (TMT) joint, extending from the medial cuneiform to mid-shaft of the first metatarsal.

Joint Preparation

Remove the bone necessary to achieve the desired intermetatarsal angle.



Optional Interfragmentary Screw Placement

Once the desired IM angle is achieved. Place a K-wire from distal to proximal through the joint starting either dorsal or plantar. Use fluoroscopy to verify placement and correction. An optional 3.0mm or 4.0mm Cannulated Lag screw can be used following the cannulated lag screw technique. The cannulated lag screw will provide compression and stabilization across the fusion site.

Compression can also be achieved using the lapidus plate with compression hole.

Plate Selection and Positioning

Select the appropriate size plate and place it either dorsal or dorsomedial over the joint. (Plate Options: 2.7mm 0mm H Plate, 2.7mm 2-4mm Step Plate, 2.7mm or 3.5mm Lapidus Plate, 3.5mm H Plate). If using the lapidus style plate with compression hole, ensure the compression hole is proximal to the joint. Temporarily fixate the plate using plate TAKs.

Plating Lapidus (Cont.)

Insert Screws

Lapidus Plate

If using the lapidus plate with compression hole. Insert the distal screws first into the metatarsal.



Insert a screw in the compression hole following the compression hole technique. Remove all temporary fixations prior to final seating of the compression screw.



For final plate fixation, insert the appropriate sized screws using the screw preparation and insertion technique.



Plating 5th Metatarsal Fracture

Surgical Approach

Make a lateral incision along the base of the 5th metatarsal, exposing the tuberosity.

Reduce the fracture.

Plate Selection and Positioning

Contour the plate as needed using the plate benders.

Position the hook plate around the 5th metatarsal tuberosity and the peroneus brevis tendon. It may be necessary to pierce through the peroneus brevis tendon with the hooks. In cases with dense bone, use the hook drill guide to make guide channels using a .062" K-wire.

Insert Screws

Partially insert the first screw distally into the elongated positioning hole.

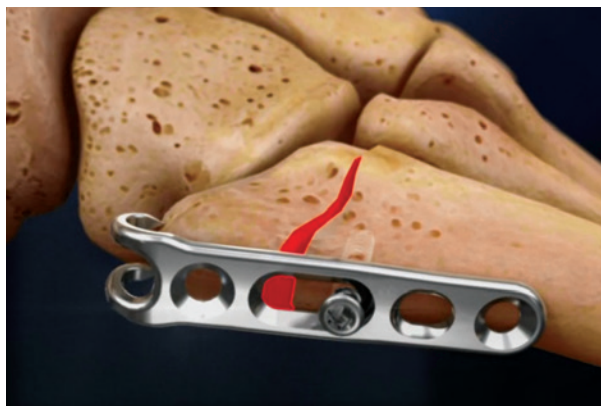

Impact the hooks into the bone fragment using the hook plate impactor.

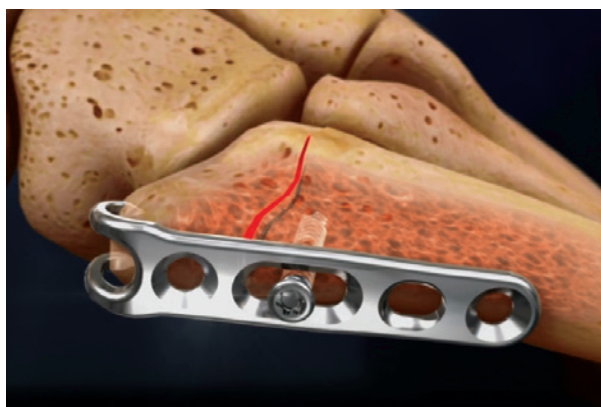

Plating 5th Metatarsal Fracture (Cont.)

Insert the distal compression screw following the compression hole technique.

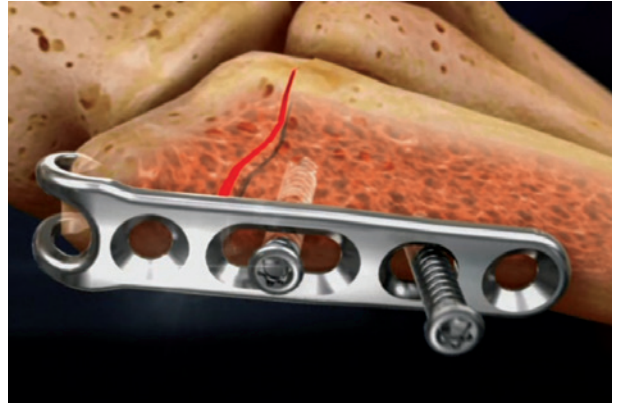

For final plate fixation, insert the appropriate sized screws using the screw preparation and insertion technique.

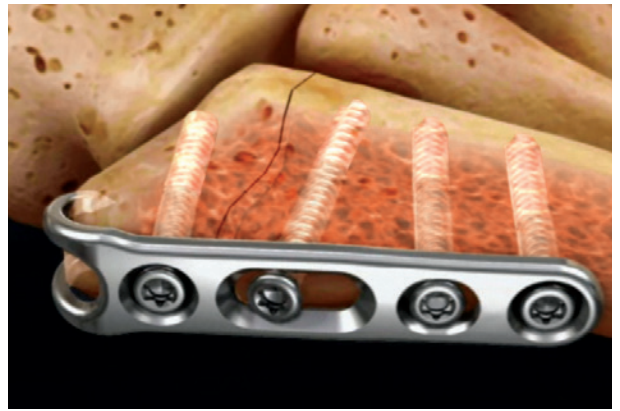

Plating Calcaneal Fracture (Lateral Extensile Approach)

Surgical Approach

Expose the fracture through a lateral extensile incision.
Expose the calcaneus by elevating a full thickness flap.

Fracture Reduction

Reduce the fracture as required, restoring the subtalar joint along with the calcaneal height and width. A Steinmann pin may be placed in the posterior tuberosity to pull the fragment out of varus and returned to anatomic length. Maintain reduction with temporary fixation.

It may be necessary when restoring the anatomic joint surface to place a cannulated lag screw from the posterior facet to the sustentaculum.

Plate Selection and Positioning

Select the appropriate size plate based on the size of the calcaneus. Mesh and pre-contoured plates are available. Plate bending templates are provided if using the mesh style plate. Contour the template to match the patient's anatomy.

Contour the plate to match the template.

Temporarily fixate the plate using plate TAKs.



Insert Screws

For final plate fixation, insert the appropriate sized screws using the screw preparation and insertion technique.

Remove TAKs



Plating Calcaneal Fracture (Sinus Tarsi Approach)

Surgical Approach

An incision is made from the lateral malleolus to the calcaneocuboid joint, taking care to avoid the peroneal tendons and the sural nerve.

Use a periosteal elevator to release the soft tissue from the lateral wall of the calcaneus, providing a pathway for the plate.

Fracture Reduction

Reduce the fracture as required, restoring the subtalar joint along with the calcaneal height and width. A Steinmann pin may be placed in the posterior tuberosity to pull the fragment out of varus and returned to anatomic length. Maintain reduction with temporary fixation.

It may be necessary when restoring the anatomic joint surface to place a cannulated lag screw from the posterior facet to the sustentaculum.

Plate Selection and Positioning

Select the appropriate size plate based on the size of the calcaneus. Insert the plate through the incision site using the plate inserter. Match the prongs of the plate inserter to the middle distal screw hole and k-wire hole.

Temporarily fixate the plate using plate Taks

Insert Screws

Following the screw preparation and insertion technique, insert the appropriate sized screws into the anterior process and posterior facet.

Locate the posterior screw holes using fluoroscopy. Make stab incisions over the screw holes and insert the appropriate sized screws following the screw insertion technique.

Remove TAKs

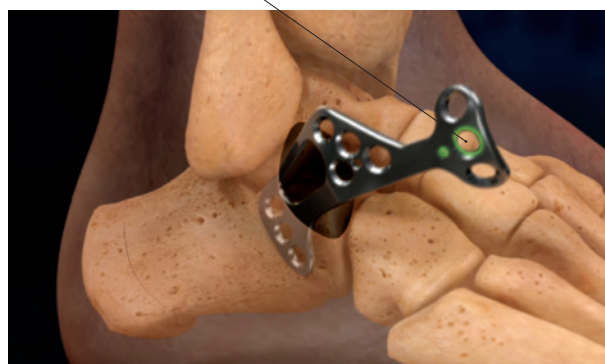
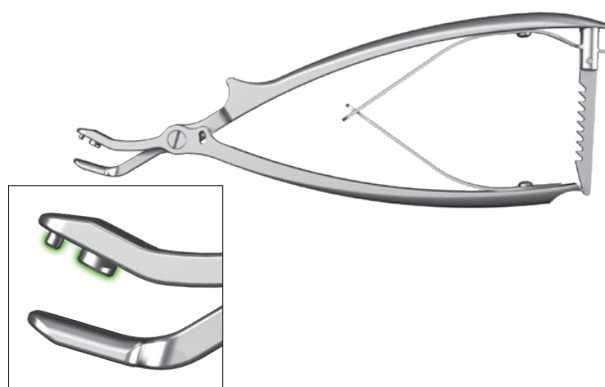

Plating Evans

Surgical Approach

Make an oblique incision proximal to the calcaneal-cuboid joint, taking care to avoid the peroneal tendons and the sural nerve.

Osteotomy

Create an osteotomy on the lateral wall of the calcaneus approximately 1cm proximal and parallel to the calcaneal-cuboid joint, leaving the medial wall intact.

Plate Selection and Positioning

Select the plate with the desired amount of correction. Insert the plate into the osteotomy site with the parallel holes closest to the calcaneal-cuboid joint. Temporarily fixate the plate to the metatarsal using plate Taks.

Insert Screws

For final plate fixation, insert the appropriate sized screws using the screw preparation and insertion technique.

Remove TAKs

Place bone graft into the osteotomy site.

Plating Calcaneal Slide

Surgical Approach

Make an “L” shaped incision on the lateral side of the calcaneus, taking care to avoid the peroneal tendons and the sural nerve.

Osteotomy

Create an osteotomy on the lateral wall of the calcaneus parallel to the posterior facet. Use an osteotome to break the medial cortex of the calcaneus.

The distal fragment is displaced medially and held with temporary fixation.

Plate Selection and Positioning

Select the plate with the desired amount of correction. Insert the plate over the osteotomy site. Temporarily fixate the plate to the metatarsal using plate TAKs.

Insert Screws

For final plate fixation, insert the appropriate sized screws using the screw preparation and insertion technique.

Remove TAKs

OsteoMed Products



ExtremiFix Headless Cannulated Screws



ExtremiFix Cannulated Screws



Large Cannulated Screws



ExtremiFuse

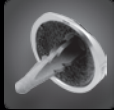

EnCompass



EnCompass Lessers



Hemi



ReFlexion



InterPhlex



Talar-Fit

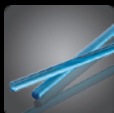

Inion



Refer to the provided Instructions for Use for the complete Indications, Contraindications, Warnings, and Instructions for Use including cleaning and sterilization details.

OSTEOMED

3885 Arapaho Rd.
Addison, TX 75001

Customer Service: 800.456.7779

Outside the U.S.: 001.972.677.4600

Fax: 800.390.2620

Fax Outside the U.S.: 001.972.677.4709

E-mail: customer.service@osteomed.com

www.osteomed.com

