



indication  
**FOCUSED solutions**



**surgical TECHNIQUE GUIDE**



*Rethinking Possibilities, Reshaping Lives*



# Table of Contents

---

System Introduction	2
● Clinical Indications, Materials and Contraindications	3
● Features	4-5
System Overview	
● Mini Fragment System	6-7
● Small Fragment System, Plates	8-9
● Medium Fragment System, Plates	10-11
● Small Fragment System, Screws	12
● Medium Fragment System, Screws	13
● Small Fragment Instrument Tray	14-15
● Medium Fragment Instrument Tray	16-17
General Surgical Technique Guide	
● Plating Preparation	18-19
● Plating with Angulated Locking or Standard Screws	19-20
● Lag Screws (M3-X)	21
● Cannulated Headless and Lag Screws (ExtremiFix®)	22
● Reamers	23
● Transfixation Technology	24
Specific Plating Techniques	
● 1 <sup>st</sup> MTP/MPJ Joint Fusion Plate with Transfixation Hole	25-29
● Lapidus Plate with Transfixation Hole	30-32
● Navicular Cuneiform Fusion Plate	33-35
● Medial Column Plate	36-38
● Hook Plate	38-40
● Calcaneal Plate	40-42
● Subcondylar Plate	43-45

# System introduction

Designed and validated by leading foot and ankle surgeons, the Foot Plating System (FPS™) is a comprehensive, advanced solution for treating common bone fractures and reconstruction of the foot and ankle. FPS™ consists of plates, screws and instruments, each designed to help the surgeon stabilize and fixate bones of the forefoot, midfoot, rearfoot or ankle region.

The implants, plates and screws are made of titanium and incorporate the OsteoMed dual-locking angled technology. This allows the surgeon to tailor the angle of screw placement into the plate for best anatomic fit and then “lock” the screw to the plate. Locked plating delivers the benefit of greater stability of the bone/plate construct over conventional non-locked plates.

The Foot Plating System also incorporates patent pending “Transfixation Technology”. This is found in its MTP/MPJ and Lapidus Plates. With this technology the screw acts as a tension band and directly resists plantar distraction. This results in a stronger biomechanical construct for fusion.

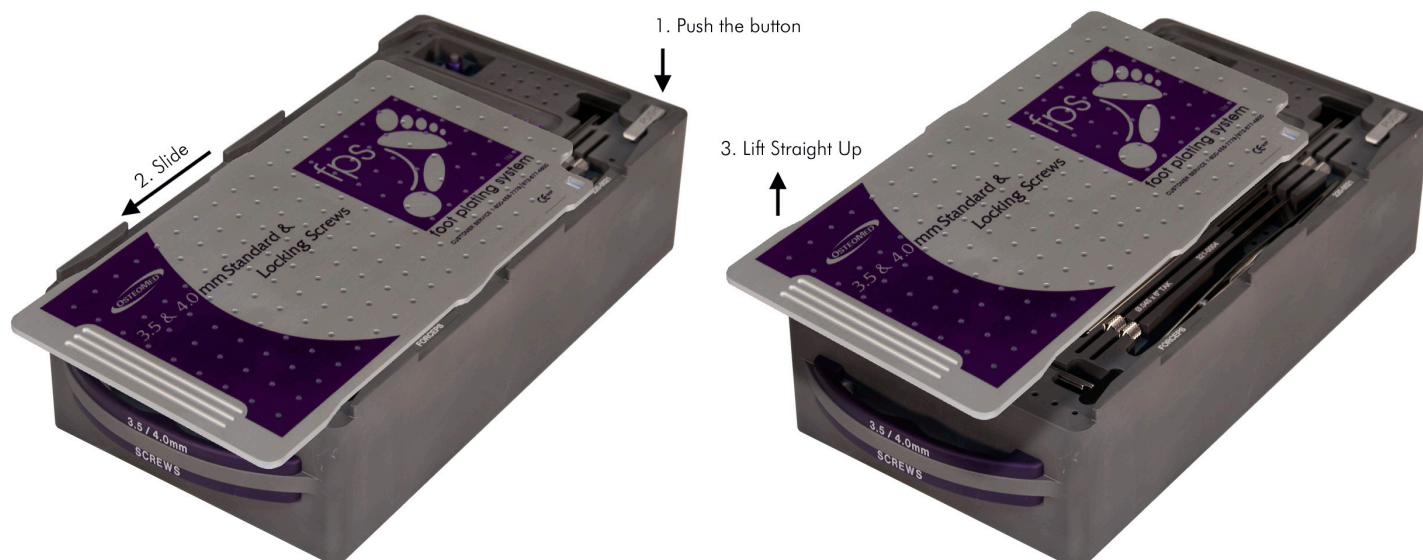

Instruction for opening the blocks:

1. Push the button located on the right bottom corner of the block
2. Slide the lid of the block away from the button
3. Lift the lid.

**\*It is not required that the lid be slid completely away from the block for removal.**

## Clinical Indications

---

OsteoMed Foot Plating System is intended for use in trauma, general surgery and reconstructive procedures of the lower extremity or other bones appropriate for the size of the device. The OsteoMed Foot Plating System implants are intended for single use only.

## EXAMPLES OF APPLICATIONS

- Metatarsal Phalangeal Joint Fusion
- Lapidus Fusion
- 5th Metatarsal Fractures
- Navicular Cuneiform Fusion
- Ankle Fusion
- Calcaneal Cuboid Fusion
- Evans Lateral Column Lengthening
- Medial Cuneiform Opening Wedge Osteotomy
- Ludoff/Mau Osteotomy
- Proximal Chevron Osteotomy
- Proximal Osteotomy of the Metatarsal
- Medial Column Fusion
- Lisfranc Arthrodesis
- Calcaneal Fractures
- Calcaneal Slide Osteotomy
- Talonavicular Fusion
- Intercuneiform Fusion
- Bunion Correction
- Proximal Opening Wedge Osteotomy
- Scarf Osteotomy

## Material

---

The plates are made from: titanium (ASTM F67) or titanium-alloy (ASTM F136 or F1472). Screws are made from titanium-alloy (ASTM F136).

The instrumentation is made from various grades of stainless steel, anodized aluminum, and/or medical grade polymers.

## Contraindications

---

Use of the OsteoMed Foot Plating System is contraindicated in the following cases:

- Active or suspected infection, or in patients who are immunocompromised;
- Patients previously sensitized to titanium or stainless steel;
- Patients with certain metabolic diseases;
- Patients exhibiting disorders which would cause the patient to ignore the physician's pre- and/ or post-operative instructions and limitations of internal rigid fixation implants;
- Percutaneous K-wire placement is contraindicated in cases of displaced fractures and compressed fractures;

# System features

## Comprehensive Locking and Non-locking system

This system incorporates dual locking technology. As the locking screw is inserted into plate, the screw threads directly into the threaded hole. Each standard screw hole also accepts non-locking screws, providing more surgical options.

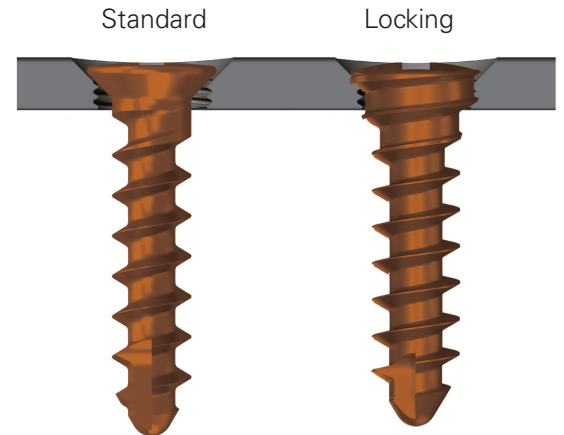

## Angled Locking

Each standard screw hole permits angled screw placement. Simply place the angled drill guide into the desired screw hole. Fixed 90° drill guides are also provided.

Each plate can accommodate a variety of locking or non-locking screws in various angles. This provides greater application options to meet surgical needs.

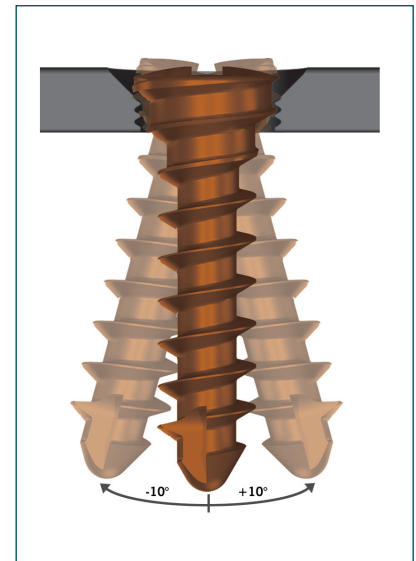

## Low Profile Plate Design

Each **FPS™** plate is low profile to minimize soft tissue irritation. The screw heads are also designed for minimal head prominence, even when inserted at an angle.

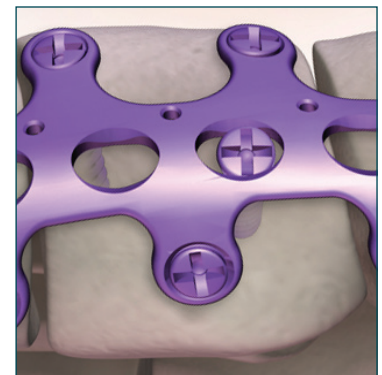

## Plate Design

**FPS™** contains a variety of plating options.

Many plates contain compression holes, which allow for active compression of different bone segments along the long axis of the plate hole. Many plates are pre-contoured.

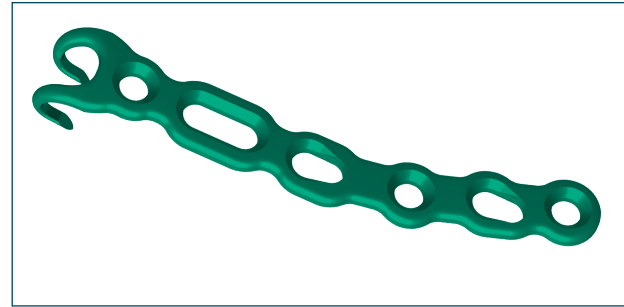

## Color Coding

Plates and screws are color coded for easy identification. Instruments have colored stripes to indicate size and mating pieces.

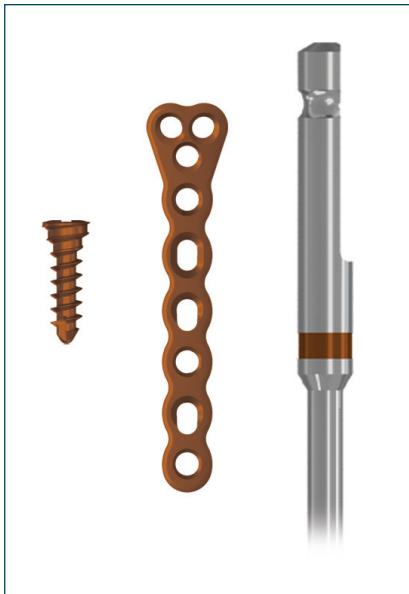

Mini Fragment screws, plates, and instruments.

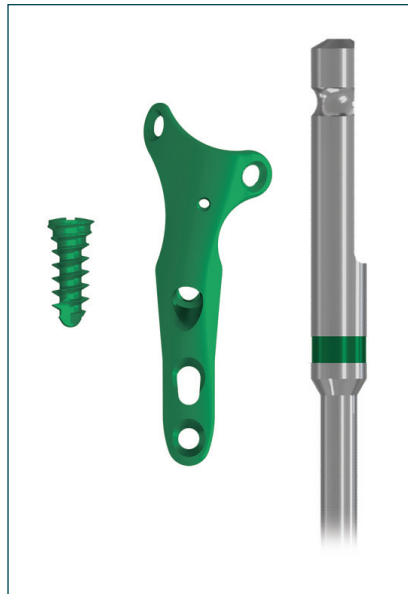

Small Fragment screws, plates, and instruments.

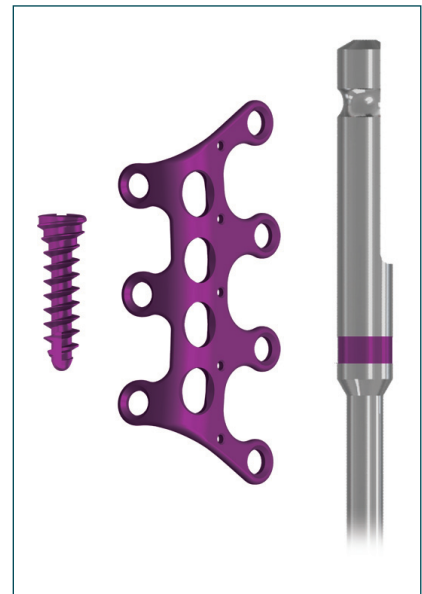

Medium Fragment screws, plates, and instruments.

# System Overview

## Mini Fragment System



### Screws



321-20XX FPS™ 2.0mm x 8mm - 22mm  
Standard Screw

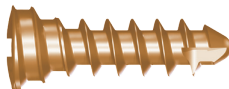

322-20XX FPS™ 2.0mm x 8mm - 22mm  
Locking Screw

## Mini Fragment Plates



324-1090  
FPS™ 2.0mm Subcondylar Plate



324-1002  
FPS™ 2.0mm X 6 Hole Straight Plate



324-1001  
FPS™ 2.0mm X 5 Hole Straight Plate



324-1000  
FPS™ 2.0mm X 4 Hole Straight Plate



324-1020  
FPS™ 2.0mm X 7 Hole T Plate, Locking



324-1021  
FPS™ 2.0mm X 7 Hole T Plate, Compression



324-1031  
FPS™ 2.0mm X 7 Hole Y Plate



324-1030  
FPS™ 2.0mm X 6 Hole Y Plate



324-1011  
FPS™ 2.0mm X 6 Hole Left L Plate



324-1010  
FPS™ 2.0mm X 6 Hole Right L Plate



324-1013  
FPS™ 2.0mm X 6 Hole  
Oblique Left L Plate



324-1012  
FPS™ 2.0mm X 6 Hole  
Oblique Right L Plate



324-1023  
FPS™ 2.0mm X 7 Hole  
Oblique Left T Plate



324-1022  
FPS™ 2.0mm X 7 Hole  
Oblique Right T Plate

## Instruments

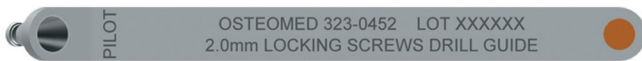

323-0452 FPS™ 2.0mm Drill Guide Locking Assembly



323-1020 FPS™ 2.0mm Driver Stem



323-1113 FPS™ 1.3mm for 2.0mm Screw Pilot Drill



323-1220 FPS™ 2.0mm Clearance Drill Bit



323-1707 FPS™ 2.0mm Countersink

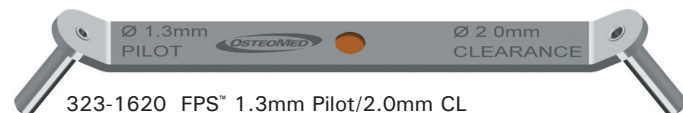

323-1620 FPS™ 1.3mm Pilot/2.0mm CL  
Drill Guide Non Locking



323-1001 FPS™ Handle Assembly



220-0027 Small Grasping Forceps



323-1720 FPS™ 2.0mm Depth Gauge Assembly

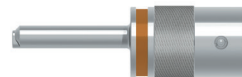

323-1920 FPS™ 2.0mm Screws  
Compression Drill Guide



323-1921 FPS™ 2.0mm Screws  
Locking Drill Guide



323-1702 FPS™ Mini Screwdriver, Ratchet Body,  
Cannulated



321-0004 Plate Holding Tak, .045" x 6"



316-0003 .045 x 4" K-Wire



321-2099 FPS™ 2.0mm Washer



# System Overview

## Small Fragment System Plates









### Instruments











323-1725 FPS<sup>®</sup> Fifth Metatarsal Hook Plate Impactor



### Displacement Plates

-  FPS™ 2.7mm  
0mm Step  
Plate  
324-1250
-  FPS™ 2.7mm  
1mm Step  
Plate  
324-1251
-  FPS™ 2.7mm  
2mm Step  
Plate  
324-1252
-  FPS™ 2.7mm  
3mm Step  
Plate  
324-1253
-  FPS™ 2.7mm  
4mm Step  
Plate  
324-1254
-  FPS™ 2.7mm  
5mm Step  
Plate  
324-1255

### Wedge Plates

- |  |  |
|--|--|
|  FPS™ 2.7mm<br>0mm Wedge<br>Plate<br>324-1260   |  FPS™ 2.7mm<br>3.5mm Wedge<br>Plate<br>324-1264 |
|  FPS™ 2.7mm<br>2.0mm Wedge<br>Plate<br>324-1261 |  FPS™ 2.7mm<br>4.0mm Wedge<br>Plate<br>324-1265 |
|  FPS™ 2.7mm<br>2.5mm Wedge<br>Plate<br>324-1262 |  FPS™ 2.7mm<br>4.5mm Wedge<br>Plate<br>324-1266 |
|  FPS™ 2.7mm<br>3.0mm Wedge<br>Plate<br>324-1263 |  FPS™ 2.7mm<br>5.0mm Wedge<br>Plate<br>324-1267 |







### Lapidus Plates

-  FPS™ 2.7mm  
Lapidus Plate  
Right  
324-1290
-  FPS™ 2.7mm  
Lapidus Plate  
Left  
324-1291

### Small Fragment Plates

-  324-1103 FPS™ 2.7mm 7 Hole Straight Compression Plate
  -  324-1102 FPS™ 2.7mm 6 Hole Straight Compression Plate
  -  324-1101 FPS™ 2.7mm 5 Hole Straight Compression Plate
  -  324-1100 FPS™ 2.7mm 4 Hole Straight Compression Plate
- |   |  |
|---|--|
| <ul style="list-style-type: none"> <li> 324-1113<br/>FPS™ 2.7mm 6 Hole<br/>Oblique L Compression<br/>Plate Left</li> <li> 324-1222<br/>FPS™ 2.7mm 6 Hole<br/>Oblique T Plate Left</li> <li> 324-1111<br/>FPS™ 2.7mm 6<br/>Hole<br/>L Plate Left</li> <li> 324-1220 FPS™ 2.7mm 6 Hole T Plate</li> </ul> | <ul style="list-style-type: none"> <li> 324-1112<br/>FPS™ 2.7mm 6 Hole<br/>Oblique L Compression<br/>Plate Right</li> <li> 324-1221<br/>FPS™ 2.7mm 6 Hole<br/>Oblique T Plate Right</li> <li> 324-1110<br/>FPS™ 2.7mm 6<br/>Hole<br/>L Plate Right</li> </ul> |
|---|--|

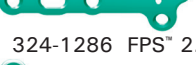

### MTP/MPJ Plates

-  324-1284 FPS™ 2.7mm 1st MTP/MPJ Plate Large Right
-  324-1285 FPS™ 2.7mm 1st MTP/MPJ Plate Large Left
-  324-1280 FPS™ 2.7mm 1st MTP/MPJ Plate Small Right
-  324-1281 FPS™ 2.7mm 1st MTP/MPJ Plate Small Left
-  324-1286 FPS™ 2.7mm 1st MTP/MPJ Primary Plate Right
-  324-1287 FPS™ 2.7mm 1st MTP/MPJ Primary Plate Left

### Subcondylar Plates

-  FPS™ 2.7mm Subcondylar Plate  
324-1190

### Hook Plates

-  FPS™ 2.7mm Hook Plate Right  
324-1270
-  FPS™ 2.7mm Hook Plate Left  
324-1271
-  FPS™ 2.7mm Hook Plate, Short  
324-1272

### Navicular Cuneiform Plates

- |  |   |
|--|---|
| <ul style="list-style-type: none"> <li> 324-1292<br/>FPS™ 2.7mm<br/>NC Fusion<br/>Plate Large</li> </ul> | <ul style="list-style-type: none"> <li> 324-1293<br/>FPS™ 2.7mm<br/>NC Fusion<br/>Plate Small</li> </ul> |
|--|---|

# System Overview

## Medium Fragment System

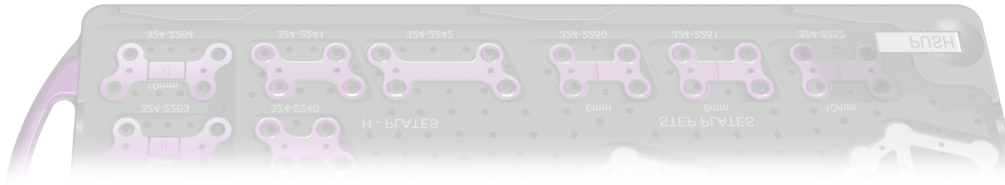
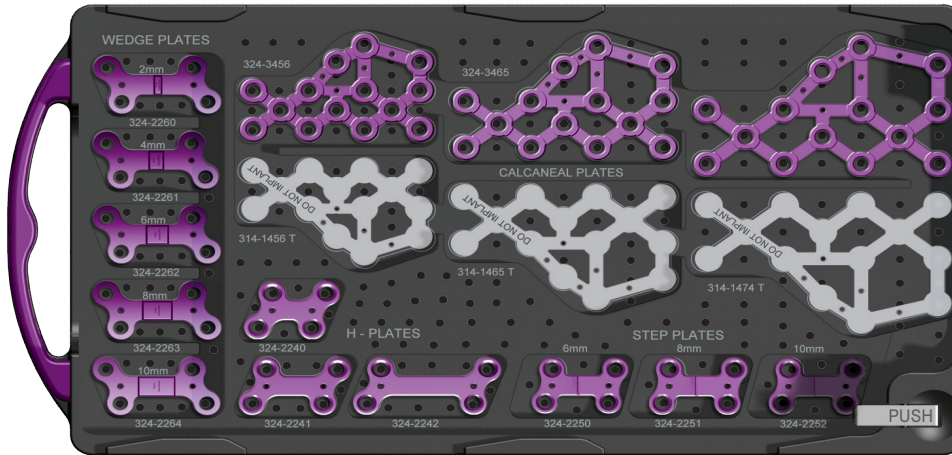
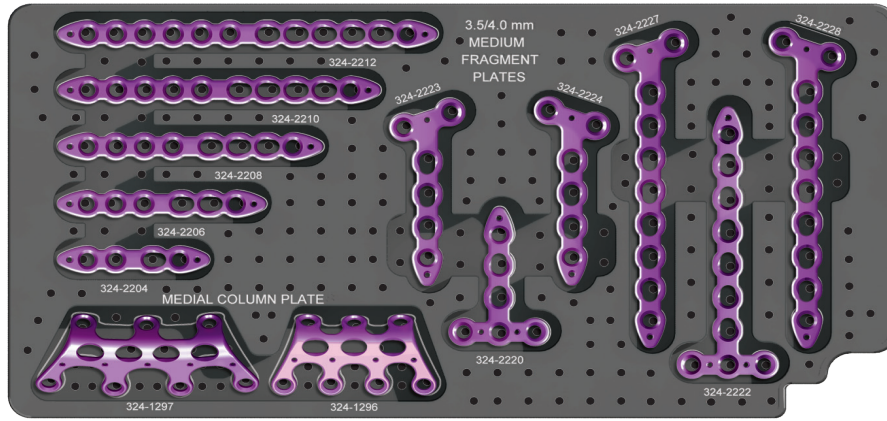

### Medium Fragment Plates



324-2212 FPS™ 3.5/4.0mm 12 Hole Straight Plate



324-2210 FPS™ 3.5/4.0mm 10 Hole Straight Plate



324-2208 FPS™ 3.5/4.0mm 8 Hole Straight Plate



324-2206 FPS™ 3.5/4.0mm 6 Hole Straight Plate



324-2204 FPS™ 3.5/4.0mm 4 Hole Straight Plate



324-2224 FPS™ 3.5/4.0mm 6 Hole Oblique T Plate Left



324-2228 FPS™ 3.5/4.0mm 10 Hole, Oblique T Left



324-2223 FPS™ 3.5/4.0mm 6 Hole Oblique T Plate Right



324-2227 FPS™ 3.5/4.0mm 10 Hole, Oblique T Right

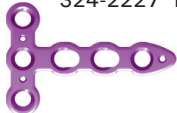

324-2220 FPS™ 3.5/4.0mm 6 Hole T Plate



324-2222 FPS™ 3.5/4.0mm 10 Hole T Plate

### H Plates



324-2240 FPS™ 3.5/4.0mm x 15 H Plate



324-2241 FPS™ 3.5/4.0mm x 20 H Plate



324-2242 FPS™ 3.5/4.0mm x 30 H Plate

### Medial Column Plates



324-1297 FPS™ 3.5/4.0mm  
Medial Column Plate Large



324-1296 FPS™ 3.5/4.0mm  
Medial Column Plate Small

### Wedge Plates



324-2260 FPS™ 3.5mm  
2mm Wedge Plate



324-2261 FPS™ 3.5mm  
4mm Wedge Plate



324-2262 FPS™ 3.5mm  
6mm Wedge Plate



324-2263 FPS™ 3.5mm  
8mm Wedge Plate



324-2264 FPS™ 3.5mm  
10mm Wedge Plate

### Step Plates



324-2250 FPS™ 3.5/4.0mm  
6mm Step Plate



324-2251 FPS™ 3.5/4.0mm  
8mm Step Plate



324-2252 FPS™ 3.5/4.0mm  
10mm Step Plate

### Calcaneal Plates



324-3456  
FPS™ Calcaneal Plate,  
56mm

314-1456T  
Calcaneal Plate,  
Template, 56mm

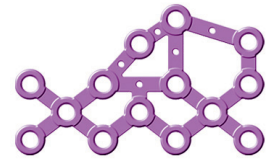

324-3465  
FPS™ Calcaneal Plate,  
65mm

314-1465T  
Calcaneal Plate,  
Template, 65mm

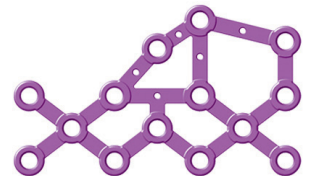

324-3474  
FPS™ Calcaneal Plate,  
74mm

314-1474T  
Calcaneal Plate,  
Template, 74mm

# System Overview

## Small Fragment System

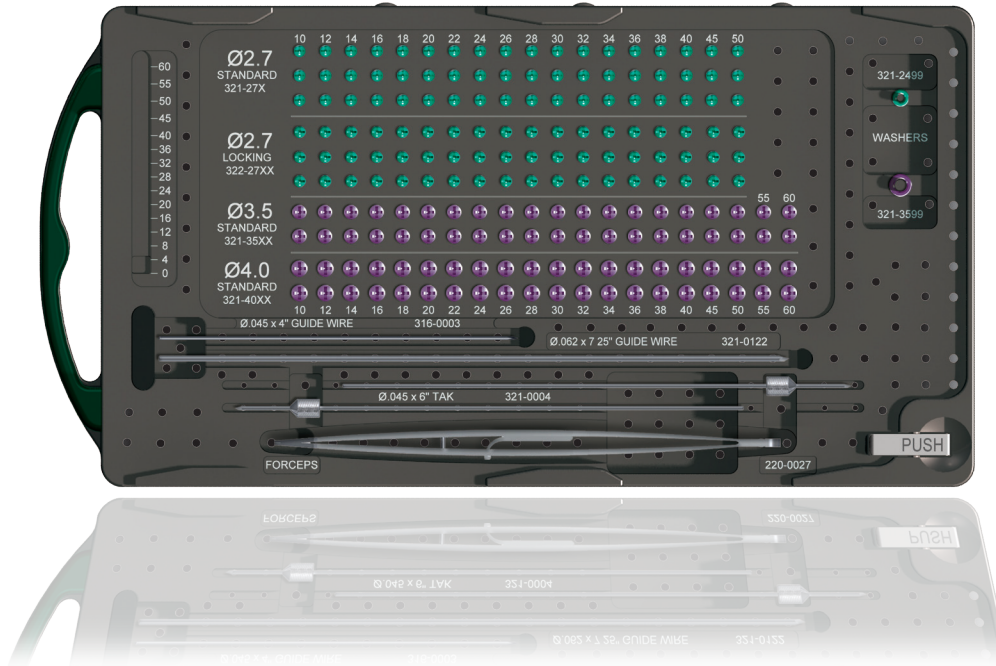

### Screws



321-27XX FPS™ 2.7mm x 10mm - 50mm Standard Screw

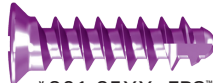

\*321-35XX FPS™ 3.5mm x 10mm - 60mm Standard Screw



322-27XX FPS™ 2.7mm x 10mm - 50mm Locking Screw

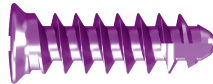

\*321-40XX FPS™ 4.0mm x 10mm - 60mm Standard Screw

\* 3.5/4.0mm Standard screws may not be inserted through small fragment plates

### Washers



321-2499 FPS™ 2.7mm Washer

### Washers



321-3599 FPS™ 3.5/4.0mm Washer

### Instruments



316-0003 .045 x 4" K-Wire



321-0122 .062 x 7.25" K-Wire



321-0004 Plate Holding Tak, .045" x 6"



220-0027 Small Grasping Forceps

# System Overview

## Medium Fragment System

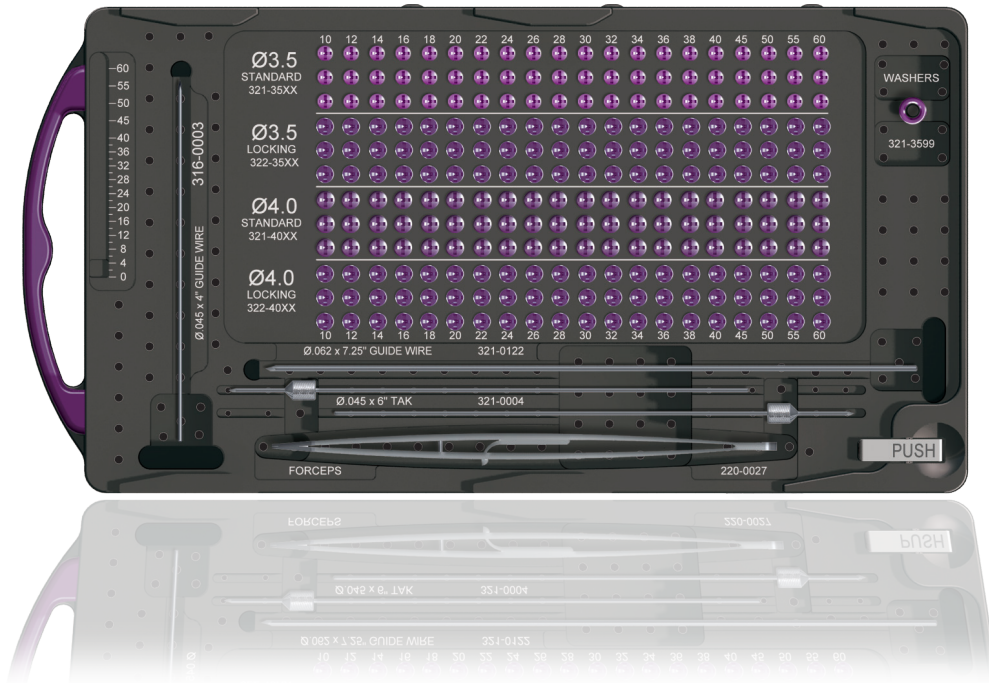

### Screws



321-35XX FPS™ 3.5mm x 10mm - 60mm  
Standard Screw

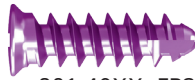

321-40XX FPS™ 4.0mm x 10mm - 60mm  
Standard Screw

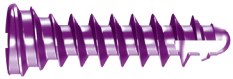

322-35XX FPS™ 3.5mm x 10mm - 60mm  
Locking Screw

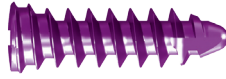

322-40XX FPS™ 4.0mm x 10mm - 60mm  
Locking Screw

### Washers



321-3599 FPS™ 3.5/4.0mm Washer

### Instruments



316-0003 .045 x 4" K-Wire



321-0122 .062 x 7.25" K-Wire



321-0004 Plate Holding Tak, .045" x 6"



220-0027 Small Grasping Forceps

# System Overview

## Small Fragment Instrument Tray



323-1714 FPS™ 2.7mm Depth Gauge Assembly

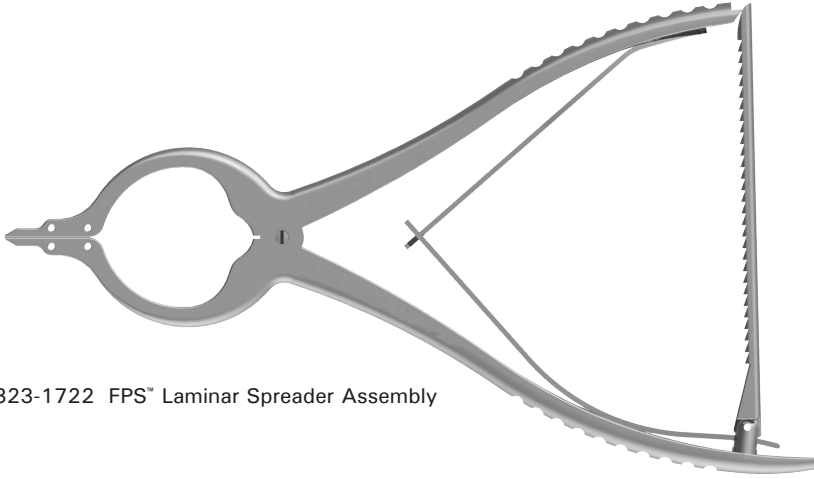

323-1722 FPS™ Laminar Spreader Assembly



323-1120 FPS™ 2.0mm for 2.7mm Screw Pilot Drill



323-1227 FPS™ 2.7mm Clearance Drill Bit



323-1708 FPS™ 2.7mm Countersink



323-1024 FPS™ 2.7mm Driver Stem



323-2127 FPS™ 2.0mm Pilot/Overdrill Drilling Guide



323-2227 FPS™ 2.0mm Angled Locking/  
Compression Guide



320-0402 Hohmann Retractor, 6" w/ 15mm Blade



320-1024 Sharp Hook



320-0401 Periosteal Elevator, 7.25" w/ 6mm Straight



320-0417 Quick Release Adapter

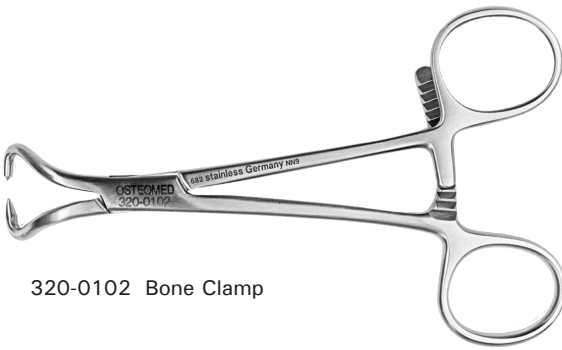

320-0102 Bone Clamp



316-0046 Bone Clamp,  
Curved Lobster Claw



323-1702 FPS<sup>™</sup> Mini Screwdriver, Ratchet Body, Cannulated

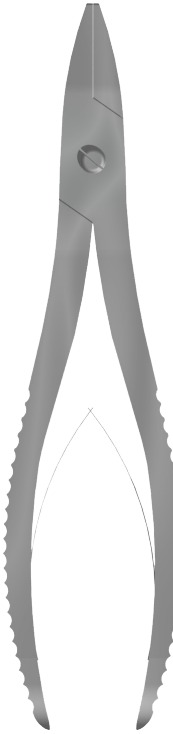

320-1016 Plate Bending Forceps



323-1716 FPS<sup>™</sup> Plate Cutter Assembly



# System Overview

## Medium Fragment Instrument Tray



320-0407 4.0mm x 228mm Steinmann Pin, Fully Threaded



320-0408 4.8mm x 229mm Steinmann Pin, Smooth



320-0409 5.4mm x 229mm Steinmann Pin, Partially Threaded



320-0402 Hohmann Retractor, 6" w/ 15mm Blade



320-1024 Sharp Hook



320-0401 Periosteal Elevator, 7.25" w/ 6mm Straight

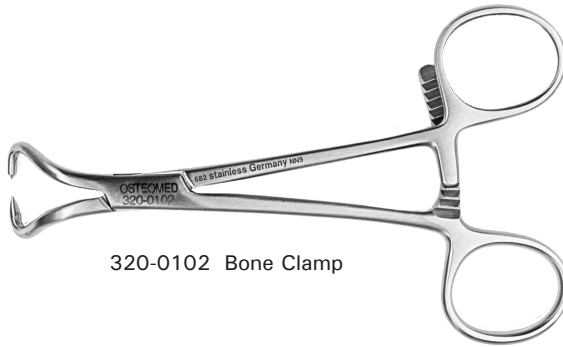

320-0102 Bone Clamp



316-0046 Bone Clamp,  
Curved Lobster Claw



320-0411 FPS™ Plate Bender Pliers

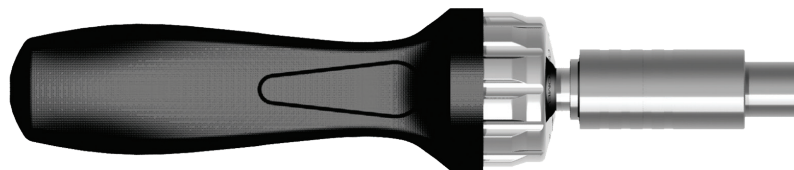

323-1703 FPS™ Small Screwdriver, Ratchet Body, Cannulated



323-1715 FPS™ 3.5/4.0mm Depth Gauge Assembly



323-1835 FPS™ 3.5/4.0mm On-Bone Plate Bender



323-1224 FPS™ 2.4mm for 3.5/4.0 Screws Pilot Drill



323-1235 FPS™ 3.5mm Clearance Drill Bit



323-1240 FPS™ 4.0mm Clearance Drill Bit



323-1709 FPS™ 3.5/4.0mm Countersink



323-1035 FPS™ 3.5/4.0mm Driver Stem



323-1935 FPS™ 3.5/4.0mm Screws  
Compression Drill Guide



323-1936 FPS™ 3.5/4.0mm Screws  
Locking Drill Guide



323-1001 FPS™ Handle Assembly

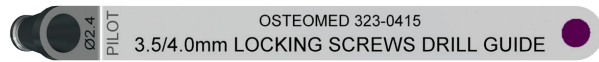

323-0415 FPS™ 3.5/4.0mm Drill Guide  
Locking Assembly

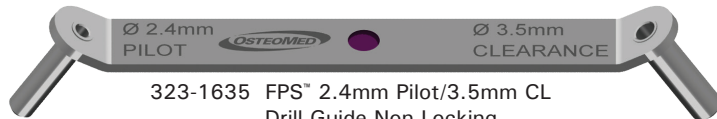

323-1635 FPS™ 2.4mm Pilot/3.5mm CL  
Drill Guide Non Locking

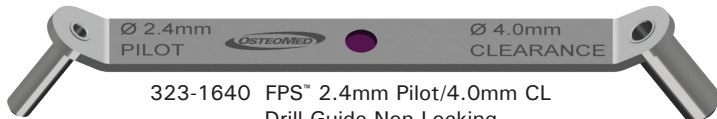

323-1640 FPS™ 2.4mm Pilot/4.0mm CL  
Drill Guide Non Locking



320-0417 Quick Release Adapter

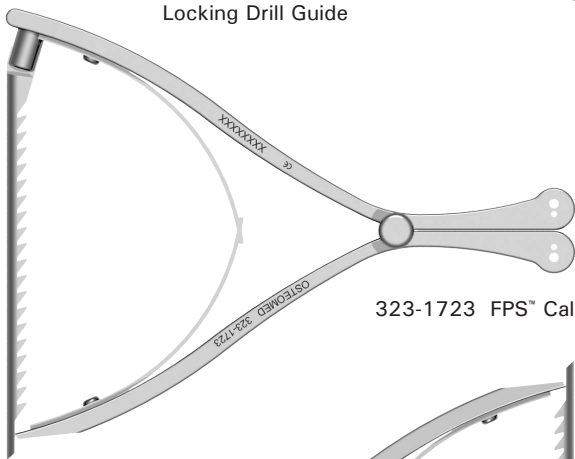

323-1723 FPS™ Calcaneal Distractor Small Straight

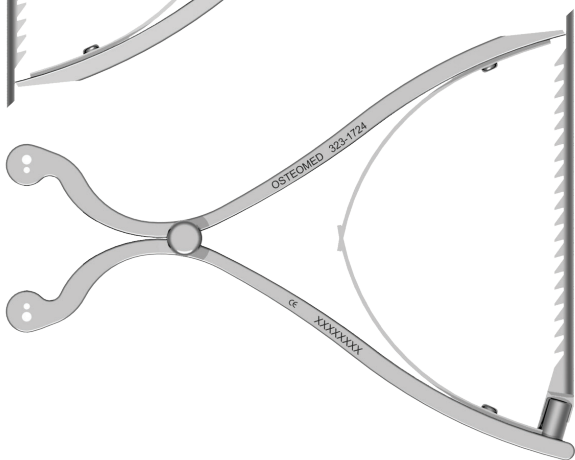

323-1724 FPS™ Calcaneal Distractor Small Bent

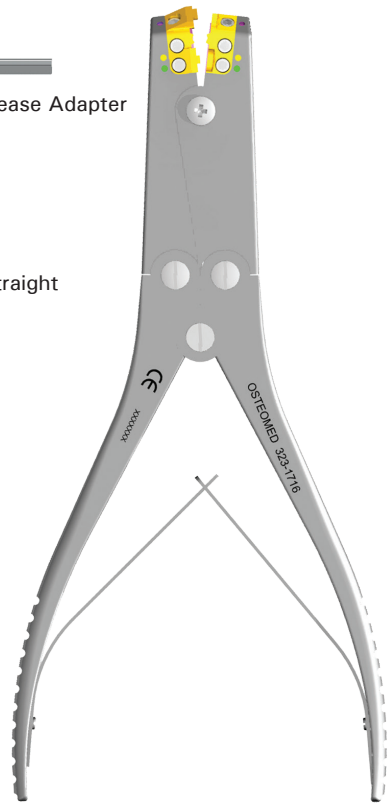

323-1716 FPS™ Plate Cutter Assembly

The OsteoMed Foot Plating System (**FPS™**) is appropriate for use in trauma, general surgery, and reconstructive procedures of the foot, ankle or other bones appropriate for the size of the device. Plates, screws, templates, drills, guide wires, Holding Taks™ and Steinmann pins are single-use items.

## Plating Preparation

1. Select the appropriate plate size and configuration.
2. If necessary, cut the plate using the **FPS™** Plate Cutter Assembly.

**Tip:** To use the plate cutter, determine how many holes need to be removed. Place the last needed hole around the appropriately sized post. The Mini Fragment and Small Fragment plates are positioned on the same post. Pull the plate slightly so that it grasps the post. Hold the plate securely with one hand and squeeze the handles to cut the plate. The silicone on the cutting tip will hold the discarded part of the plate\*. Inspect the plate for burrs and remove them using the diamond file located on the top of the instrument.

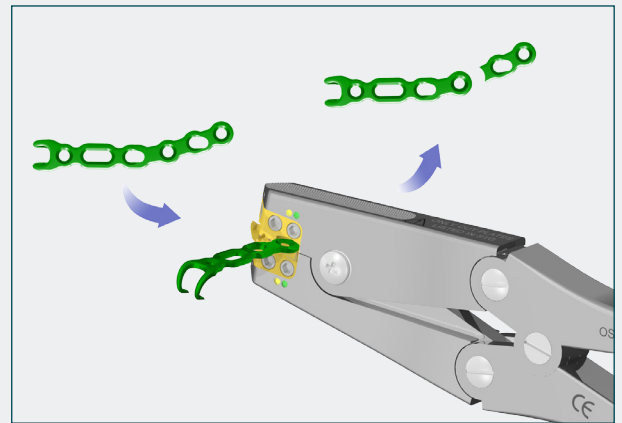

**Note:** Plate cutters are available for use on the following plates:

- Mini Fragment plates: 324-10XX
- Small Fragment plates: 324-11XX, 324-122X
- Hook plates: 324-1270, 324-1271
- Navicular Cuneiform plate: 324-1292
- Calcaneal plates: 324-34XX

3. Contour plate as needed using the plate benders.

**WARNING:** *Bending the plate multiple times may weaken the plate and could result in implant failure. It is recommended to place the plate benders in adjacent plate holes during use. Bending across the plate holes may deform the screw holes and prevent the locking screw from fully seating.*

**Note:** On-bone plate benders are available for use on the following plates:

- Mini Fragment plates: 324-10XX
- Small Fragment plates: 324-11XX, 324-122X
- Small Fragment H-plates: 324-126X
- Hook plates: 324-1270, 324-1271
- Navicular Cuneiform plate: 324-1292
- Calcaneus plates: 324-34XX

\* Remove any plate pieces from the silicone before proceeding

4. Position the plate over the fracture or osteotomy. The plate may be temporarily held in place using K-wires or the Holding Taks™.

### **Holding Taks™**

The OsteoMed **FPS™** Holding Taks™ can be inserted into the plate holes with a wire/pin driver to temporarily fixate the plate. Long K-wire ends can be burdensome to bend or work around. Holding Taks™ can be cut at the end of the head after insertion to provide more visibility and space in the surgical site. The Holding Taks™ can be removed by rotating and pulling on the knurled head either by hand or with an appropriate instrument.

## **Plating with Angulated Locking or Standard Screws**

**Note: Multiplanar fluoroscopy is recommended throughout screw and plating procedures.**

1. Expose and reduce the surgical site.
2. Select appropriate plate for fixation of fracture or osteotomy.
3. If necessary, cut the plate using the Plate Cutter. Refer to General Plating Preparation on p. 18-19 for detailed instructions.
4. Contour the plate as needed using the plate benders. Refer to General Plating Preparation on p. 18-19 for detailed instructions.

***WARNING: Bending the plate multiple times may weaken the plate and could result in implant failure.***

5. Position the plate over the bone segments to confirm sizing.
6. Use K-wires or Holding Taks™ to temporarily hold the plate in place on the bone.
7. Determine desired screw diameter and type: Angulated Locking or Standard.

**Note: Standard screws are required in all compression and transfixation holes. All remaining screw holes will accept both Standard and Angulated Locking screws.**

8. Select the appropriate pilot drill guide and insert it into the first plate hole nearest the surgical site. Standard and angled drill guides are available.

**Tip:** Lag screws are provided for applications where compression across the fracture line by the screw is advantageous. Clearance overdrills are also provided to create a gliding hole in the proximal fragment to achieve the lag effect with a fully-threaded screw. To achieve compression, the screw must be perpendicular to the fracture line and the threads must pass into the distal fragment.

**Tip:** Many plates have oblong compression holes designed to achieve compression across the fracture line. See step 12 for additional direction.

9. Drill pilot hole using the appropriate drill size at the desired angle, within plus or minus 10° from perpendicular to the plate.

**WARNING:** When placing additional screws, ensure that subsequent screw placement does not interfere with the other screws.

**Note:** While the screw heads are designed to sit flush with the plate, screw head prominence will vary at severe angles. Screw head prominence may cause soft tissue irritation.

**Note:** Use irrigation when pilot drilling.

10. Insert the depth gauge until it passes through the distal cortex. Retract the stem until the lip catches against the bone to determine measurement.
11. Select the desired screw diameter and length accordingly. Verify the screw length with the gauge on the block. Insert the screw into the drilled hole to fixate the plate onto the bone. Fluoroscopy is recommended to ensure correct length and angulation.

**Tip:** To engage the head of the screw onto the self-retaining screwdriver shaft, insert the driver straight into the screw head with force. To remove the driver tip from the screw, rock slightly from side to side and lift.

12. Repeat steps 7 through 11 for remaining screw placement.

**Tip:** If compression is desired, several **FPS™** plates contain oblong compression holes. Place standard or locking screws through the plate and into the bone on one side of the fracture. Then, on the opposite side of the fracture, place the compression drill guide in the compression hole closest to the fracture line. The guide should be oriented with the arrow pointing toward the fracture line, in the direction of compression. Drill using the proper pilot drill. Measure the depth, insert the appropriate standard screw, and tighten. Screw insertion will pull the fragment towards the previously retained segment.

<u>Screw Diameter</u>	<u>Compression Distance</u>
2.0mm	1.2mm
2.7mm	2.2mm
3.5/4.0mm	2.2mm

Insert additional Angulated Locking or Standard screws until all necessary holes are filled.

**WARNING:** Multiple insertions of a locking screw into the same hole may compromise the locking ability of the screw driving through the plate. If a second insertion is desired, a non-locking screw should be selected for that hole, or the surgeon should select a new plate/hole location if locking capability is desired.

13. Close the surgical site using standard closure techniques.

## Lag Screws (M3-X™)

**Note:** *Multiplanar fluoroscopy is recommended throughout screw and plating procedures.*

1. Expose and reduce the surgical site.

**Note:** *Anatomic reduction is very important as the axial force necessary to insert the lag screw could displace the fragments at the fracture, osteotomy, or arthrodesis line. K-wires or Holding Taks™ may be used for temporary fixation.*

2. Drill pilot hole using the appropriate drill guide and drill.

**Note:** *Use irrigation when pilot drilling.*

3. Countersinking is recommended in cases of dense bone to create a recess for the screw head. Use the appropriate countersink if necessary.

4. Insert the depth gauge until it passes through the distal cortex. Retract the stem until the lip of the device catches against the bone to determine measurement. Subtract appropriately for any anticipated interfragmentary compression resulting from screw insertion.

5. Select the appropriate screw diameter and length. Verify the length with the gauge on the block.

**Note:** *To engage the head of the screw onto the self-retaining screwdriver shaft, insert the driver straight into the screw head with force. To remove the driver tip from the screw, rock slightly from side to side and lift.*

6. Drive the screw to compress the fracture or osteotomy.

7. Repeat steps 2 through 6 for additional screw placement.

8. Close the treatment site using standard closure techniques.

## Cannulated Headless and Cannulated Lag Screws (ExtremiFix™)

**Note:** *Multiplanar fluoroscopy is recommended throughout screw and plating procedures.*

**Note:** *Cannulated screws are not recommended for use through FPS™ plate holes except for the 3.0mm cannulated transfixation screw option for the 1st MTP/MPJ plates.*

1. Expose and reduce the surgical site.

**Note:** *Anatomic reduction is very important as the axial force necessary to insert the lag screw could displace the fragments at the fracture, osteotomy, or arthrodesis line. K-wires or Holding Taks® may be used for temporary fixation.*

2. Insert a K-wire to the appropriate depth under fluoroscopy. Do not bend K-wire when placing it in the bone.
3. Slide the cannulated depth gauge over the K-wire until the tip bottoms out on bone; the end of the K-wire will indicate the screw length required. Subtract appropriately for any anticipated interfragmentary compression resulting from screw insertion.
4. If necessary or desired, use the countersink to create a recess in the bone for cannulated lag screws.
5. ExtremiFix® cannulated screws are self drilling and self tapping, but drilling is recommended in cases of dense bone. If drilling is desired or necessary, select the appropriate cannulated drill and use the cannulated drill guide located in the cannulated block to drill a pilot hole. Additionally, for headless screws, the proximal cortex drill is recommended to create a pilot hole for the trailing end of the screw.

**Note:** *Use irrigation when pilot drilling.*

6. Select the appropriate screw diameter and length. Verify the screw length with the gauge on the block.
7. Place the screw over the K-wire and use the cannulated driver to implant the screw until the screw is fully seated.
8. Remove and discard the K-wire.
9. Repeat steps 2 through 8 for additional screw placement.

**WARNING:** *When placing additional screws, ensure that subsequent screw placement does not interfere with the other screws.*

10. Close the surgical site using standard closure techniques.

## Use Of Reamers

1. Open the joint and fully release the ligaments. Ensure the joint is fully distracted.
2. Use the metatarsal sizing template provided in the reamer block to determine the appropriate reamer size for the metatarsal head. It is recommended to start with the reamer one size larger than was measured and work down through smaller sizes to ensure the desired metatarsal surface size is achieved.
3. Insert the metatarsal guide pin through the articulating surface and up the metatarsal shaft. Insertion should begin at the central axis and travel plantarly at the desired angle for flexion.
4. After placing the appropriate concave reamer over the guide pin, use power to ream until bleeding bone is reached.
5. Use the phalangeal sizing template provided in the reamer block to determine the appropriate reamer size for the phalangeal base. It is recommended to start with the reamer one size smaller than was measured and work up through larger sizes to ensure the desired phalangeal surface size is achieved.
6. Insert the phalangeal guide wire through the articulating surface and down the central axis of the phalangeal base.
7. After placing the appropriate convex reamer over the guide wire, use power to ream until bleeding bone is reached.
8. Position the phalanx and metatarsal appropriately for fixation. K-wires may be used to temporarily hold the bones in close proximity.

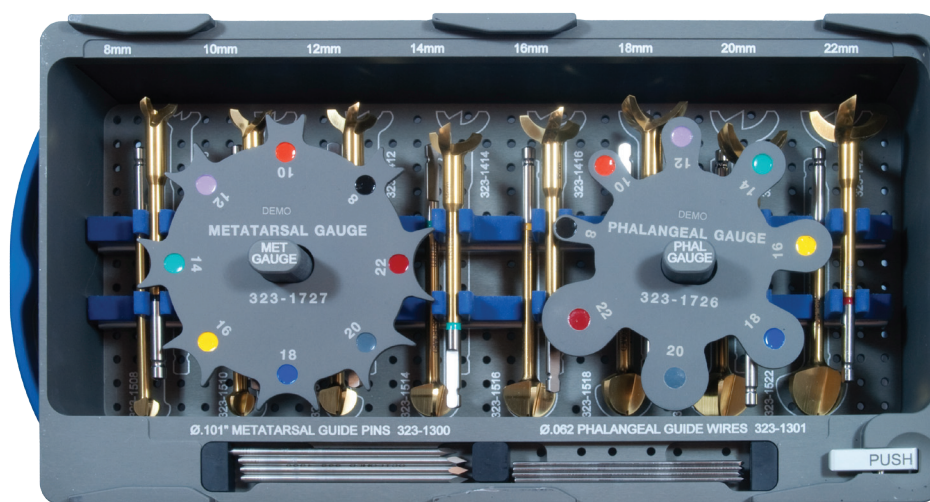



## Transfixation Technology

Transfixation screws are available for use with the 1<sup>st</sup> MTP/MPJ fusion and Lapidus plates. Current common practice in arthrodesis cases is to plate these joints and/or use two crossed screws across the joints. These techniques keep the bones on either side of the joint in close proximity, but do not completely eliminate plantar distraction. If used, the plate is typically placed on the dorsal side of the foot due to physiological constraints. However, flexibility in the plate and relevant bones allows recurring minor distraction at the plantar aspect of the joint with each dorsiflexion of the foot. Crossed screws are typically positioned through the neutral axis, or middle, of the joint, which keeps the bones in apposition but does not resist plantar distraction. Conversely, the transfixation screw in the OsteoMed Foot Plating System runs from the dorsal side of the foot, through the joint, and into the plantar aspect of the opposing bone in the joint. This screw acts as a tension band and directly resists plantar distraction. Thus, the plate/transfixation screw combination results in a stronger biomechanical structure for fusion.

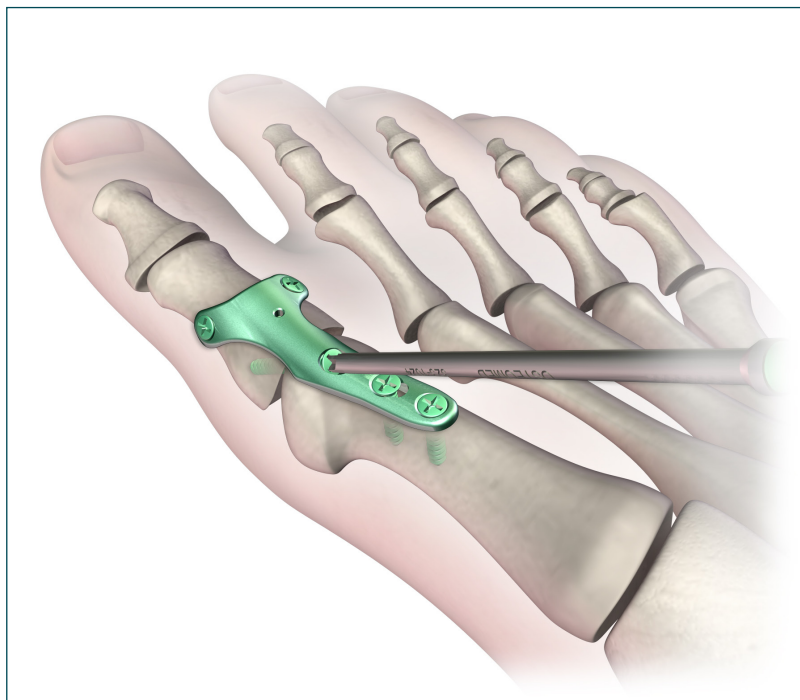

# 1st MTP/MPJ Joint Fusion Plate with Transfixation Hole

(324-1280, 324-1281, 324-1284, 324-1285, 324-1286, 324-1287)

**Note:** *Multiplanar fluoroscopy is recommended throughout screw and plating procedures.*

1. Expose and reduce the surgical site.
2. Debride the base of the phalanx and the metatarsal head to bleeding bone. If desired, a range of spherical reamer sizes in a secondary block is available.

**Note:** *Instructions for using the reamers can be found on p. 23.*

3. Position the toe with desired dorsiflexion and valgus angle, and bring the phalanx and metatarsal in close apposition. K-wires may be used to hold the bones in close proximity.

**Note:** *The two larger 1st MPJ/MTP fusion plates are pre-contoured with 10° dorsiflexion and 10° hallux valgus. The smallest 1st MPJ/MTP fusion plate is pre-contoured with 10° dorsiflexion. Additional contouring can be achieved using the plate benders. Each plate is available in left and right configurations.*

4. Temporarily fixate the plate to the bones with K-wires or Holding Taks™.

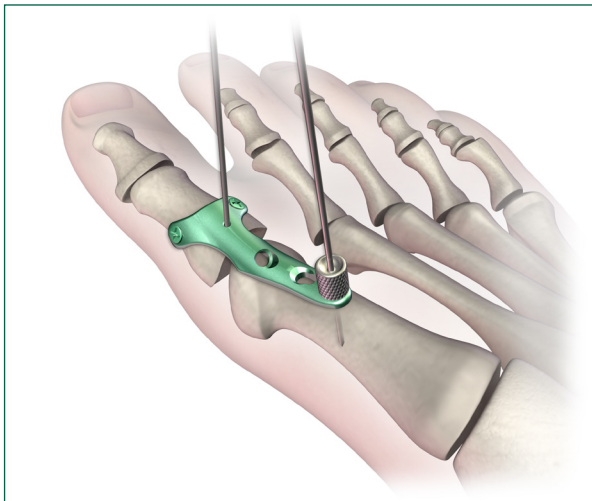

5. Select the appropriate pilot drill guide and insert it into the first plate hole nearest the joint space on the phalanx side. An angled drill guide is available.

6. Drill a pilot hole in the phalanx at the desired angle using the appropriate drill size, within plus or minus 10° from perpendicular to the plate.

**WARNING:** *When placing additional screws, ensure that subsequent screw placement does not interfere with the other screws.*

**Note:** *While the screw heads are designed to sit flush with the plate, screw head prominence will vary at severe angles. Screw head prominence may cause soft tissue irritation.*

**Note:** *Use irrigation when pilot drilling.*

7. Insert the depth gauge until it passes through the distal cortex. Retract the stem until the lip catches against the bone to determine measurement.
8. Select a 2.7mm screw of desired length for use in the phalanx. Verify the screw length with the gauge on the block. Insert the screw into the drilled hole to fixate the plate onto the bone. Fluoroscopy is recommended to ensure correct length and angulation.

**Tip:** To engage the head of the screw onto the self-retaining screwdriver shaft, insert the driver straight into the screw head with force. To remove the driver tip from the screw, rock slightly from side to side and lift.

9. Repeat steps 5-8 in the remaining holes over the phalanx.
10. Remove and discard any K-wires or Holding Taks® positioned through the metatarsal.
11. Select the compression drill guide and insert it into the compression hole nearest the joint space on the metatarsal side.

**Note:** *If desired, the transfixation screw may be inserted prior to filling the compression hole. Please see “Transfixation and Compression Insert”.*

# TRANSFIXATION AND COMPRESSION

The transfixation screw may be inserted prior to the compression screw to obtain both transfixation and compression across the joint with the same screw.

1. Select the appropriate drill guide and pilot drill through the transfixation screw hole.

**Note:** Use irrigation when pilot drilling.

**Optional:** Overdrill the proximal cortex with a clearance drill to create a lag effect.

**Optional:** A 3.0mm cannulated lag screw may be used in the transfixation hole. Please refer to the general instructions for implantation of cannulated screws.

2. Insert the depth gauge until it passes through the distal cortex. Retract the stem until the lip catches against the bone to determine measurement.
3. Select the 2.7mm screw of desired length for use in the transfixation hole. Verify the screw length with the gauge on the block. Insert the screw into the drilled hole. Fluoroscopy is recommended to ensure correct length and angulation.
4. Select the standard pilot drill guide and insert it into the compression hole nearest the joint space on the metatarsal side.

**Note:** Do not use the compression drill guide. Use the standard drill guide and fill this hole with the screw in the neutral position.

5. Drill the pilot hole through the compression hole into the metatarsal, check the length, and insert the appropriately sized 2.7mm screw using the driver.

**Note:** Use irrigation when pilot drilling.

6. Pilot drill the remaining metatarsal screw holes and insert appropriately sized 2.7mm screws.
7. Remove and discard K-wires or Holding Taks<sup>®</sup>.
8. Close the treatment site using standard closure techniques.

- 12.** Drill pilot hole through the compression hole into the metatarsal, check the length, and insert the appropriately sized 2.7mm screw using the driver.

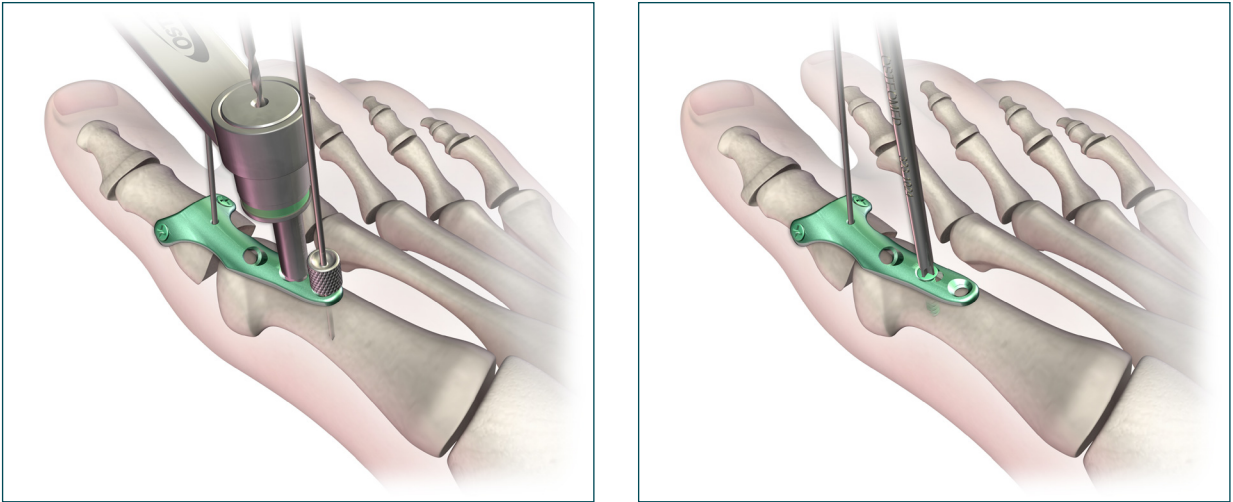

**Note:** Use irrigation when pilot drilling.

- 13.** Pilot drill the remaining metatarsal screw holes and insert appropriately sized 2.7mm screws.

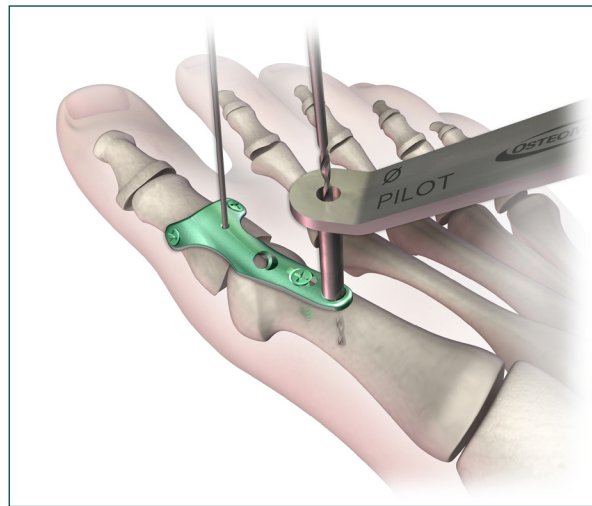

- 14.** Remove and discard remaining K-wires or Holding Taks<sup>®</sup>.
- 15.** Select the appropriate drill guide and pilot drill through the transfixation screw hole.

**Note:** Use irrigation when pilot drilling.

**Optional:** Overdrill the proximal cortex with a clearance drill to create a lag effect.

**Optional:** A 3.0mm cannulated lag screw may be used in the transfixation hole.  
Please refer to the general instructions for implantation of cannulated screws.

16. Insert the depth gauge until it passes through the distal cortex of the phalanx. Retract the stem until the lip catches against the bone to determine measurement.
17. Select the 2.7mm standard screw of desired length for use in the transfixation hole. Verify the screw length with the gauge on the block. Insert the screw into the drilled hole. Fluoroscopy is recommended to ensure correct length and angulation.

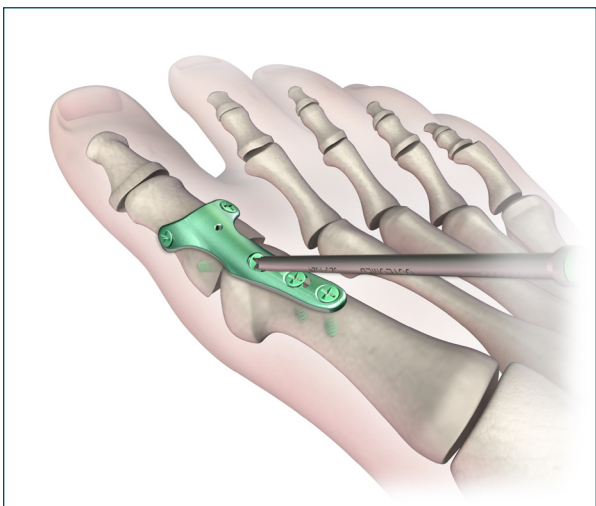

18. Close the treatment site using standard closure techniques.

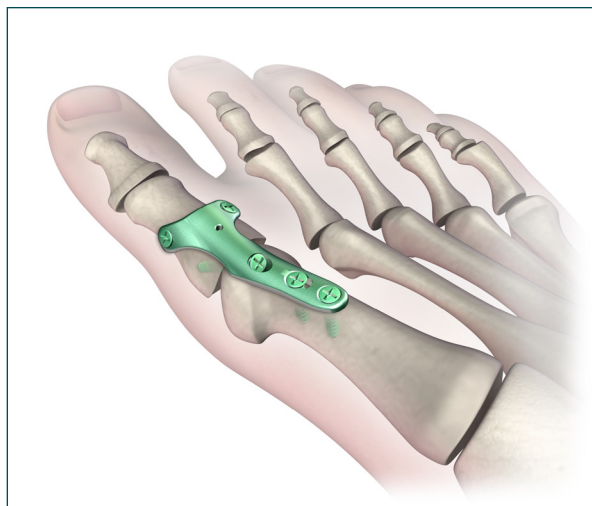

# Lapidus Plate with Transfixation Hole

(324-1290, 324-1291)

**Note:** *Multiplanar fluoroscopy is recommended throughout screw and plating procedures.*

1. Expose and reduce the surgical site.
2. Debride the joints between the bones to be fused.
3. Secure the bones to be fused with K-wires or a bone clamp.
4. Contour the plate as needed using the plate benders. Refer to General Plating Preparation on p. 18-19 for detailed instructions.

**WARNING:** *Bending the plate multiple times may weaken the plate and could result in implant failure.*

5. Temporarily attach the plate to the bones with K-wires or Holding Taks<sup>®</sup>.

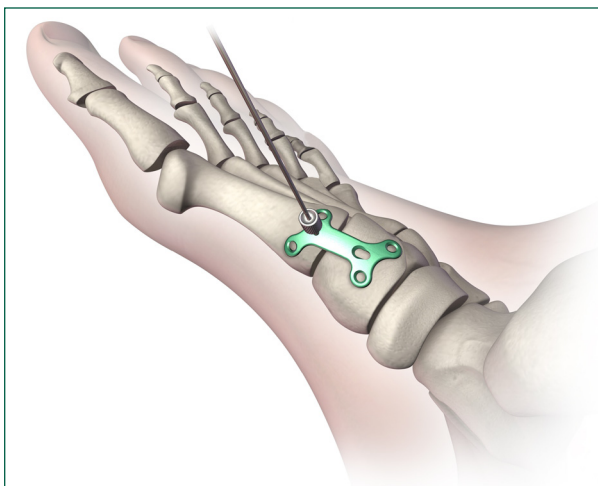

6. Select the appropriate drill guide for the 2.7mm screws and insert it into one of the plate holes on the metatarsal. Standard and angled drill guides are available.
7. Use the 2.0mm pilot drill to drill a pilot hole in the metatarsal at the desired angle, within plus or minus 10° from perpendicular to the plate.

**Note:** *While the screw heads are designed to sit flush with the plate, screw head prominence will vary at severe angles. Screw head prominence may cause soft tissue irritation.*

**Note:** *Use irrigation when pilot drilling.*

8. Insert the depth gauge until it passes through the distal cortex. Retract the stem until the lip catches against the bone to determine measurement.

9. Select a 2.7mm screw of appropriate length. Verify the screw length with the gauge on the block. Insert the screw into the drilled hole to fixate the plate onto the bone. Fluoroscopy is recommended to ensure correct length and angulation.

**Tip:** To engage the head of the screw onto the self-retaining screwdriver shaft, insert the driver straight into the screw head with force. To remove the driver tip from the screw, rock slightly from side to side and lift.

**WARNING:** *When placing additional screws, ensure that subsequent screw placement does not interfere with the other screws.*

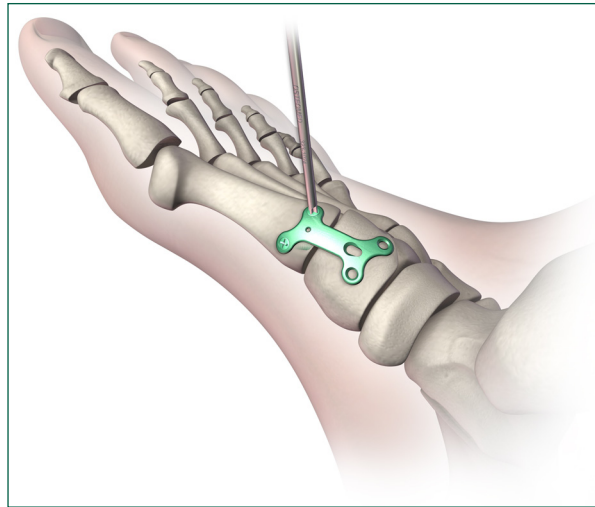

10. Repeat steps 6-9 in the remaining hole over the metatarsal.
11. Select the 2.7mm screws compression drill guide and insert it into the compression hole over the first cuneiform.
12. Using the 2.0mm pilot drill for the 2.7mm screws, drill the pilot hole, check the length with the depth gauge, and insert the appropriately sized 2.7mm screw using the driver.  
**Note:** *Use irrigation when pilot drilling.*
13. Repeat steps 6-9 in the remaining holes over the first cuneiform.



**14.** Insert the depth gauge until it passes through the distal cortex. Retract the stem until the lip catches against the bone to determine measurement. If using cannulated screws, slide the cannulated depth gauge over the K-wire until the tip bottoms out on bone; the end of the K-wire will indicate the screw length required.

**15.** Select a 2.7mm screw of appropriate length. Verify the screw length with the gauge on the block. Insert the screw into the drilled hole. Fluoroscopy is recommended to ensure correct length and angulation.

**Tip:** To engage the head of the screw onto the self-retaining screwdriver shaft, insert the driver straight into the screw head with force. To remove the driver tip from the screw, rock slightly from side to side and lift. If using a cannulated screw, place the screw over the K-wire and use the driver to implant the screw until the screw is fully seated.

**16.** Close the treatment site using standard closure techniques.

# Navicular Cuneiform Fusion Plate

( 324-1292, 324-1293)

*Note: Multiplanar fluoroscopy is recommended throughout screw and plating procedures.*

*Note: The Navicular Cuneiform fusion plate is designed to slide under the dorsal neurovascular bundle. Make sure to protect the bundle during the fixation procedure.*

1. Expose and reduce the surgical site.
2. Debride the joints between the bones to be fused.
3. Select the appropriately sized plate.
4. If necessary, cut the plate using the Plate Cutter. Refer to General Plating Preparation on p. 18-19 for detailed instructions.
5. Contour the plate as needed using the plate benders. Refer to General Plating Preparation on p. 18-19 for detailed instructions.

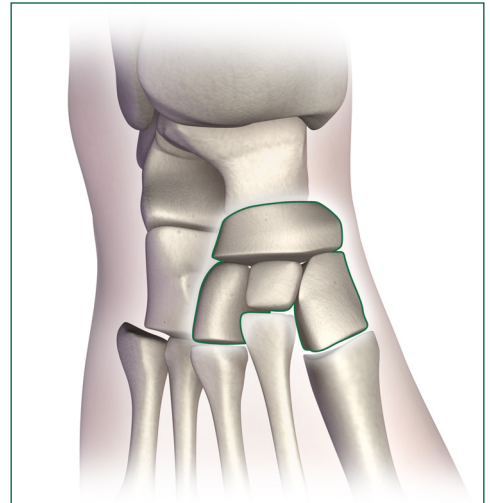

**WARNING: Bending the plate multiple times may weaken the plate and could result in implant failure.**

6. Temporarily position the bones using K-wires or a bone clamp.
7. Temporarily fixate the plate to the bones using K-wires or Holding Taks<sup>®</sup>.

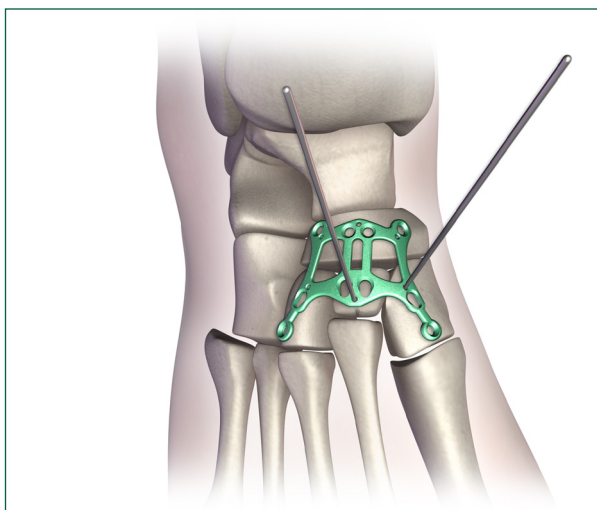

8. Select the appropriate drill guide for the 2.7mm screws and insert it into one of the plate holes above the navicular. Standard and angled drill guides are available.
9. Drill the pilot hole in the navicular at the desired angle using the 2.0mm pilot drill for the 2.7mm screws, within plus or minus 10° from perpendicular to the plate.

**Note:** While the screw heads are designed to sit flush with the plate, screw head prominence will vary at severe angles. Screw head prominence may cause soft tissue irritation.

**Note:** Use irrigation when pilot drilling.

10. Insert the depth gauge until it passes through the distal cortex. Retract the stem until the lip catches against the bone to determine measurement.
11. Select a 2.7mm screw of desired length for use in the navicular. Verify the screw length with the gauge on the block. Insert the screw into the drilled hole to fixate the plate onto the bone. Fluoroscopy is recommended to ensure correct length and angulation.

**Tip:** To engage the head of the screw onto the self-retaining screwdriver shaft, insert the driver straight into the screw head with force. To remove the driver tip from the screw, rock slightly from side to side and lift.

**WARNING:** When placing additional screws, ensure that subsequent screw placement does not interfere with the other screws.

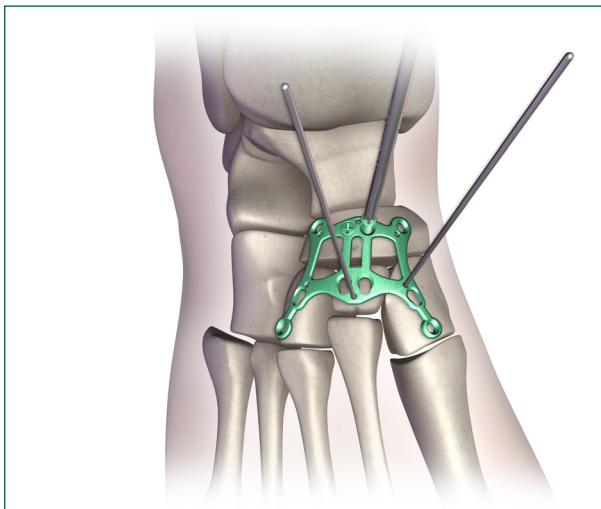

12. Repeat steps 8-11 to insert remaining screws into the navicular.
13. Use the 2.7mm compression drill guide and the 2.7mm pilot drill to pilot drill through the most medial compression hole and into the first cuneiform.

**Note:** Use irrigation when pilot drilling.

14. Remove the distal K-wire or Holding Tak<sup>®</sup> prior to compression screw placement.
15. Using the depth gauge, select a Standard 2.7mm standard screw of appropriate length and insert it into the compression hole with the driver.
16. Repeat steps 13-15 for the remaining compression holes, compressing the medial joints first and proceeding laterally.
17. If desired, satellite holes are available to insert additional screws. Use the appropriate drill guide and pilot drill through the holes at the desired angle, within plus or minus 10° from perpendicular to the plate. An angled drill guide is available. Using the depth gauge, select the 2.7mm screw of appropriate length and insert it with the driver.

**WARNING:** *When placing additional screws, ensure that subsequent screw placement does not interfere with the other screws.*

**Note:** *While the screw heads are designed to sit flush with the plate, screw head prominence will vary at severe angles. Screw head prominence may cause soft tissue irritation.*

**Note:** *Use irrigation when pilot drilling.*

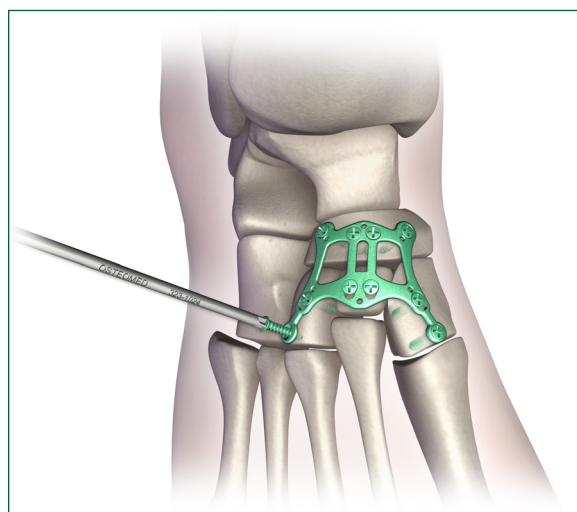

18. Remove and discard any remaining K-Wires and Holding Taks<sup>®</sup>.
19. Close the treatment site using standard closure techniques.

**Tip:** This plate can be used in conjunction with additional, independent screws, such as cannulated headless screws.

# Medial Column Plate

(324-1296, 324-1297)

**Note:** *Multiplanar fluoroscopy is recommended throughout screw and plating procedures.*

1. Expose and reduce the surgical site.
2. Debride the joints between the bones to be fused.
3. Select the appropriately sized plate.
4. Contour the plate as needed using the plate benders. Refer to General Plating Preparation on p. 18-19 for detailed instructions.

**WARNING:** *Bending the plate multiple times may weaken the plate and could result in implant failure.*

5. Temporarily position the bones using K-wires or a bone clamp.
6. Temporarily fixate the plate to the bones, under the tibialis anterior tendon, using K-wires or Holding Taks<sup>®</sup>. The side of the plate with four holes is to be positioned dorsally.

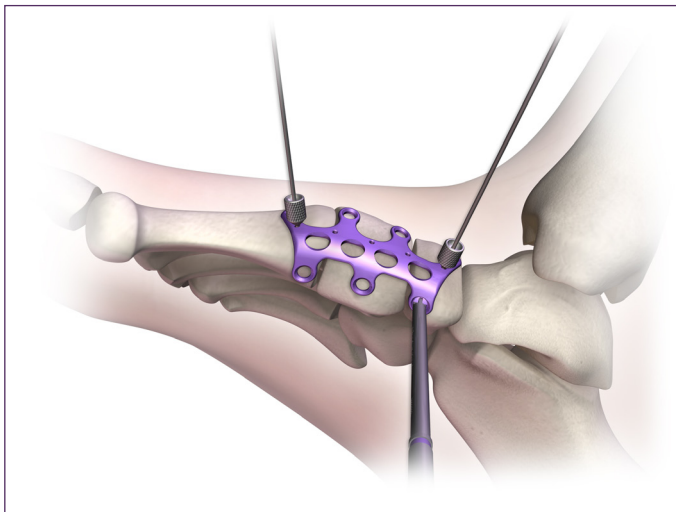

7. Screw insertion progresses from proximal to distal. Select the appropriate drill guide for the 3.5/4.0mm screws and insert it into the plate hole above the most proximal bone to be fixated. Standard and angled drill guides are available.

**Note:** *After the plate holes are filled in the most proximal bone to be fused, compression holes should be filled before the outlying holes in subsequent bones to be fused.*

8. Drill a pilot hole at the desired angle using the 2.4mm pilot drill for 3.5/4.0mm screws, within plus or minus 10° from perpendicular to the plate.

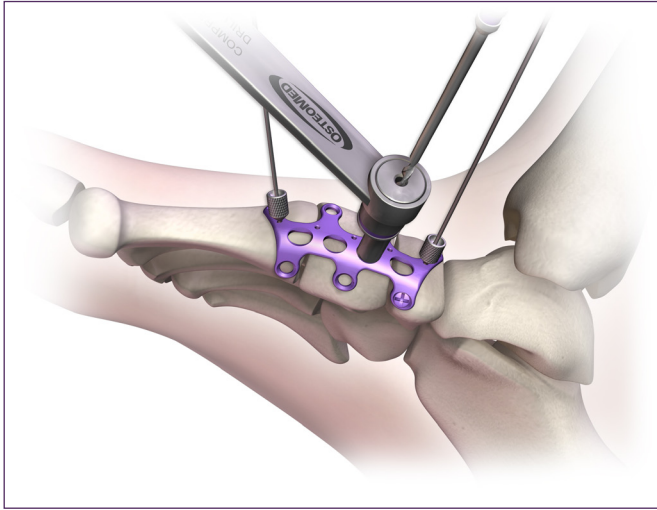

**Note:** While the screw heads are designed to sit flush with the plate, screw head prominence will vary at severe angles. Screw head prominence may cause soft tissue irritation.

**Note:** Use irrigation when pilot drilling.

9. Remove the distal K-wires or Holding Taks® prior to using compression holes.
10. Insert the depth gauge until it passes through the distal cortex. Retract the stem until the lip catches against the bone to determine measurement.
11. Select the 3.5mm or 4.0mm standard screw of appropriate length. Verify the screw length with the gauge on the block. Insert the screw into the drilled hole to fixate the plate onto the bone. Fluoroscopy is recommended to ensure correct length and angulation.

Tip: To engage the head of the screw onto the self-retaining screwdriver shaft, insert the driver straight into the screw head with force. To remove the driver tip from the screw, rock slightly from side to side and lift.

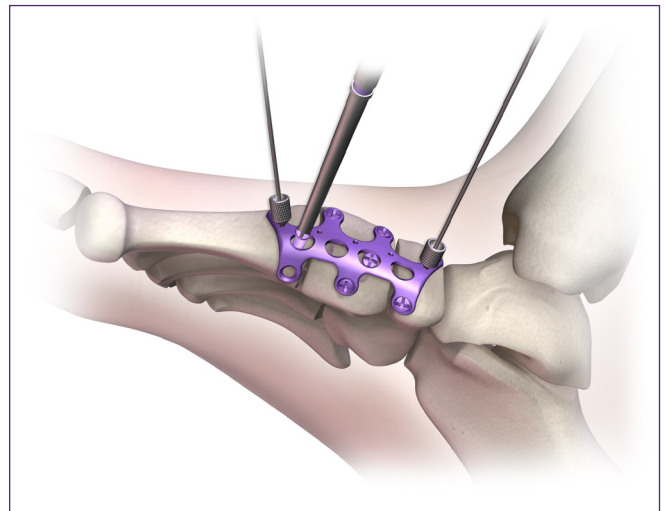

12. Repeat steps 7-11, making sure to fill the holes most proximal first and proceeding distally.

**Note:** Compression holes should be filled before the outlying holes in a particular bone.

13. To use the compression holes, insert the 3.5/4.0mm screws compression drill guide into the desired compression hole.
14. Drill the pilot hole, check the length using the depth gauge, and insert appropriately sized 3.5mm or 4.0mm screw using the driver.

**WARNING:** *When placing additional screws, ensure that subsequent screw placement does not interfere with the other screws.*

**Note:** *Use irrigation when pilot drilling.*

15. Remove and discard any remaining K-wires or Holding Taks.
16. Close the treatment site using standard closure techniques.

**Tip:** This plate can be used in conjunction with additional, independent screws.

## Hook Plate

(324-1270, 324-1271, 324-1272)

**Note:** *Multiplanar fluoroscopy is recommended throughout screw and plating procedures.*

1. Expose and reduce the surgical site.
2. Clamp the fractured bones in close apposition.
3. If necessary, cut the plate using the Plate Cutter. Refer to General Plating Preparation on p. 18-19 for detailed instructions.
4. Contour the plate as needed using the plate benders. Refer to General Plating Preparation on p. 18-19 for detailed instructions.

**WARNING:** *Bending the plate multiple times may weaken the plate and could result in implant failure.*

5. Position the plate on the clamped bones, ensuring that the hooks will capture the fragment.

**Note:** *If dense cortex is expected, drill burr holes in the bone fragment to allow easier hook penetration.*

**Tip:** The on-bone plate benders can be inserted into a distal locking hole and used to manipulate the plate and achieve initial compression.

- Using the appropriate drill guide and drill for the 2.7mm screws, drill a pilot hole as distally as possible in the elongated positioning hole.

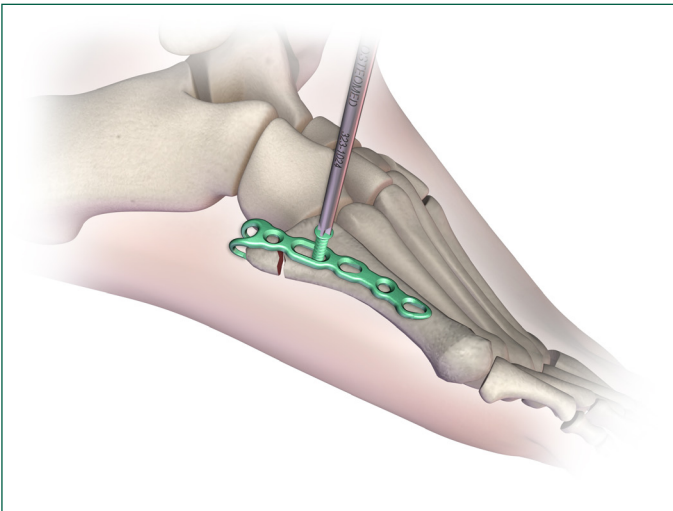

**Note:** Use irrigation when pilot drilling.

- Insert the depth gauge until it passes through the distal cortex. Retract the stem until the lip catches against the bone to determine measurement.
- Select the 2.7mm screw of appropriate length. Verify the screw length with the gauge on the block. Insert the screw into the elongated positioning hole without fully seating the head of the screw. Fluoroscopy is recommended to ensure correct length and angulation.

**Tip:** To engage the head of the screw onto the self-retaining screwdriver shaft, insert the driver straight into the screw head with force. To remove the driver tip from the screw, rock slightly from side to side and lift.

- Impact the hooks into the bone fragment, using the hook plate impactor.

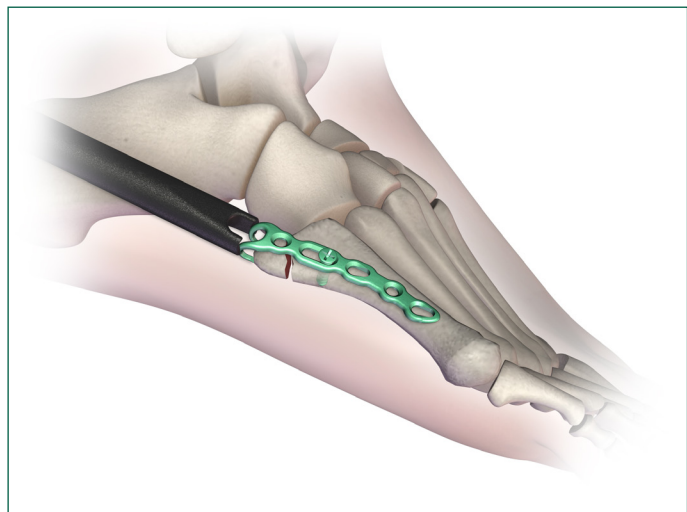



10. Select the 2.7mm screws compression drill guide and insert it into the compression hole nearest the elongated positioning hole.
11. Drill the pilot hole through the compression hole and into the metatarsal, check the length using the depth gauge, and insert and fully seat the appropriately sized 2.7mm screw using the driver.

**Note: Use irrigation when pilot drilling. Fluoroscopy is recommended to ensure correct screw length and angulation.**

12. Fully seat the screw previously placed through the elongated positioning hole.
13. Insert any additional screws if desired.
14. Close the treatment site using standard closure techniques.

## Calcaneal Plate

(324-3456, 324-3465, 324-3474)

**Note: Multiplanar fluoroscopy is recommended throughout screw and plating procedures.**

1. Expose the fracture through a standard lateral extensile incision. Expose the calcaneus by elevating a full thickness flap. K-wires placed into the bone can be bent upwards to help reflect the raised skin flap to improve exposure.
2. Reduce the fracture as required, restoring the subtalar joint along with the calcaneal height and width. Maintain reduction with temporary fixation.
3. Select the appropriate plate bending template based on the size of the calcaneus. Position the template over the calcaneus. Verify template size and contour the template to match the patient's anatomy. Verify that the temporary fixation will not interfere with the plate placement.

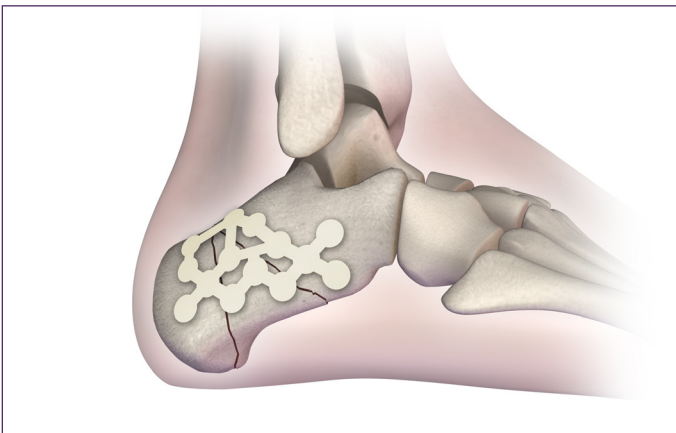

4. Select the appropriate plate corresponding to the template size.  
Plates can be used on the left or right side.
5. Contour the plate to match the template. Plates can be cut with plate cutters if necessary.  
Refer to General Plating Preparation on p. 18-19 for detailed instructions.

**WARNING: Bend the plate using the plate benders provided to avoid deforming the screw holes. Bending across the plate holes may deform the screw holes and prevent the locking screw from fully seating. Bending the plate multiple times may weaken the plate and could result in implant failure.**

6. Place the plate over the fracture site. Temporarily fixate the plate to the bones using K-wires or Holding Taks™.
7. Select the appropriate drill guide and insert it into the first plate hole just inferior to the posterior facet of the calcaneus. Standard and angled drill guides are available.
8. Drill the pilot hole at the desired angle using the 2.4mm pilot drill for the 3.5/4.0mm screws, within plus or minus 10° from perpendicular to the plate.

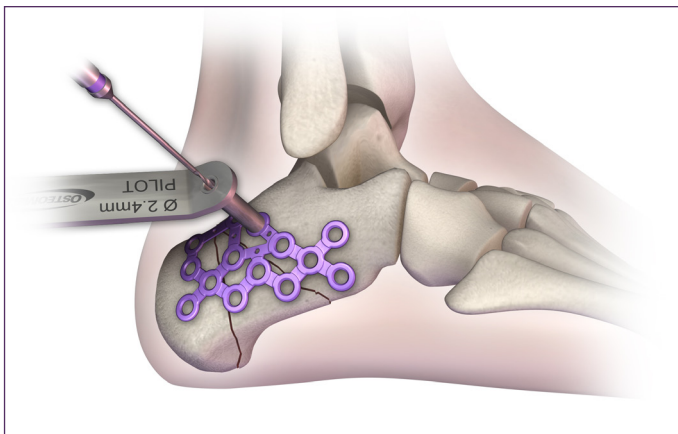

**Note: While the screw heads are designed to sit flush with the plate, screw head prominence will vary at severe angles. Screw head prominence may cause soft tissue irritation.**

**Note: Use irrigation when pilot drilling.**

9. If a lag effect is desired, insert the appropriate clearance drill guide into the plate hole previously drilled with the pilot drill and drill the proximal fragment using the corresponding clearance drill.

**Note: Use irrigation when drilling.**

10. Insert the depth gauge until it passes through the distal cortex. Retract the stem until the lip catches against the bone to determine measurement.

11. Select a 3.5mm or 4.0mm screw of appropriate length. Verify the screw length with the gauge on the block. Insert the screw into the drilled hole to fixate the plate onto the bone. When possible, place a second screw at the posterior calcaneal facet. Fluoroscopy is recommended to ensure correct length and angulation.

**Tip:** To engage the head of the screw onto the self-retaining screwdriver shaft, insert the driver straight into the screw head with force. To remove the driver tip from the screw, rock slightly from side to side and lift.

**WARNING:** *When placing additional screws, ensure that subsequent screw placement does not interfere with the other screws.*

12. Repeat steps 8-11 to insert the remaining screws. It is not necessary to place a screw in every available hole as long as desired fixation has been achieved.

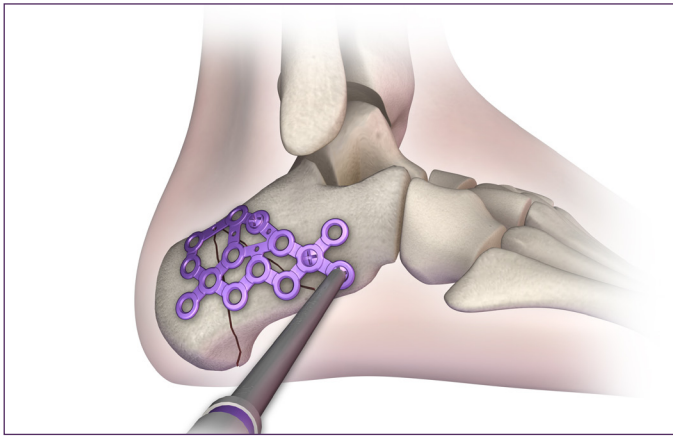

**Note:** *If a locking screw does not fully engage the plate, replace with a non-locking screw.*

**WARNING:** *Do not place screws that protrude into the joint area.*

13. If necessary, fine bending may be achieved in situ with the threaded on-bone plate benders in adjacent holes. Apply incremental force to achieve the desired contour.

**WARNING:** *Avoid over-bending as the benders may dislodge from the plate hole and damage the plate threads.*

14. Confirm fracture reduction, restoration of the calcaneal anatomy, and hardware placement with fluoroscopy.

15. Irrigate and close the treatment site using standard closure techniques.

# Subcondylar Plate

(324-1090, 324-1190)

**Note:** *Multiplanar fluoroscopy is recommended throughout screw and plating procedures.*

1. Expose and reduce the surgical site.
2. Clamp the fractured bones in close apposition.
3. If necessary, cut the plate using the Plate Cutter. Refer to General Plating Preparation on p. 18-19 for detailed instructions.
4. Contour the plate as needed using the plate benders. Refer to General Plating Preparation on p. 18-19 for detailed instructions.

**WARNING:** *Bending the plate multiple times may weaken the plate and could result in implant failure.*

5. Position the plate with the wide end apposed to the condyle. The plate has a 12° bend that allows the screws to be placed at broader angles in order to fixate the fracture.
6. Temporarily fixate the plate to the bones using K-wires or Holding Taks<sup>®</sup>.

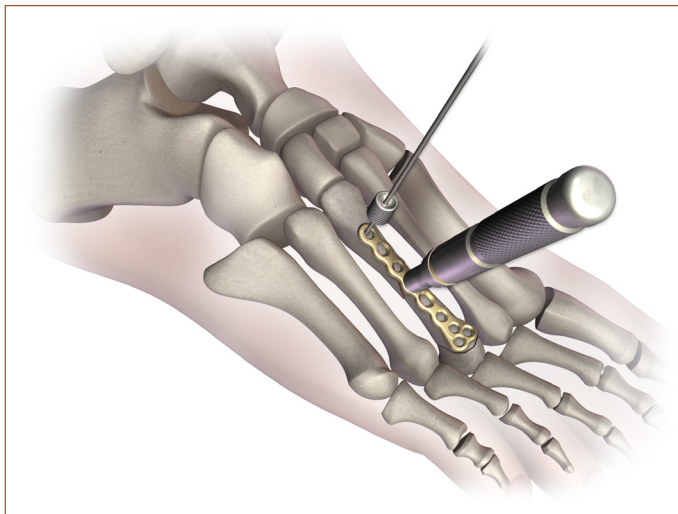

- Using the appropriate drill guide and drill, drill a pilot hole in the middle of the elongated positioning hole.

**Note:** Use irrigation when pilot drilling.

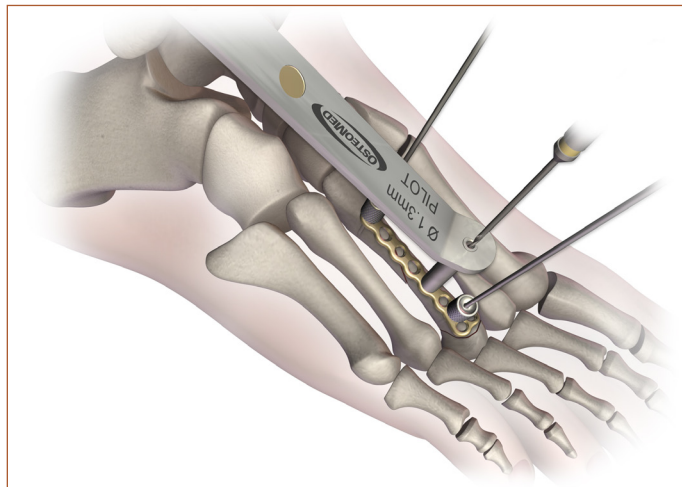

- Insert the depth gauge until it passes through the distal cortex. Retract the stem until the lip catches against the bone to determine measurement.

- Select the desired non-locking screw of appropriate length. Verify the screw length with the gauge on the block. Insert the screw into the elongated positioning hole without fully seating the head of the screw. Fluoroscopy is recommended to ensure correct length and angulation.

**Tip:** To engage the head of the screw onto the self-retaining screwdriver shaft, insert the driver straight into the screw head with force. To remove the driver tip from the screw, rock slightly from side to side and lift.

- Using the appropriate drill guide and drill, pilot drill through the holes in the cluster above the metaphysis, check the lengths using the depth gauge, and insert the appropriately sized screws using the driver. Standard and angled drill guides are available.

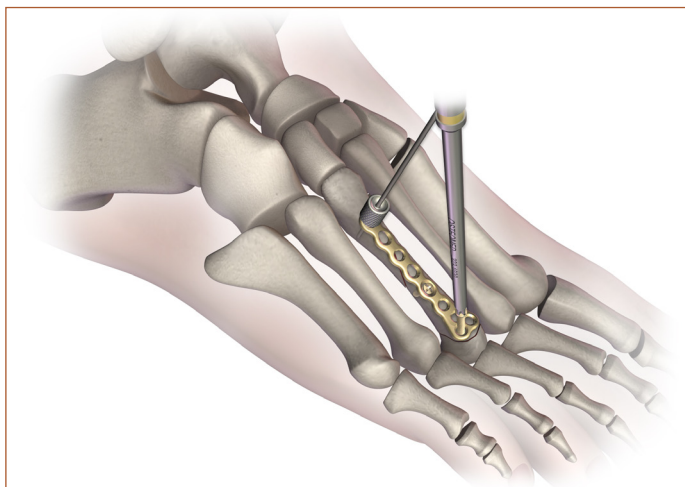

**Note:** Fluoroscopy is recommended to ensure correct screw length and angulation.

11. Select the appropriate compression pilot drill guide and insert it into the compression hole nearest the elongated positioning hole.
12. Drill the pilot hole through the compression hole and into the bone, check the length using the depth gauge, and insert the appropriately sized screw using the driver.

**Note:** *Use irrigation when pilot drilling. Fluoroscopy is recommended to ensure correct screw length and angulation.*

13. Using the appropriate drill guide and drill, pilot drill through the holes above the shaft, check the lengths using the depth gauge, and insert the appropriately sized screws using the driver until the remaining holes are filled.
14. Fully seat the screw previously placed through the elongated positioning hole.
15. Close the treatment site using standard closure techniques.

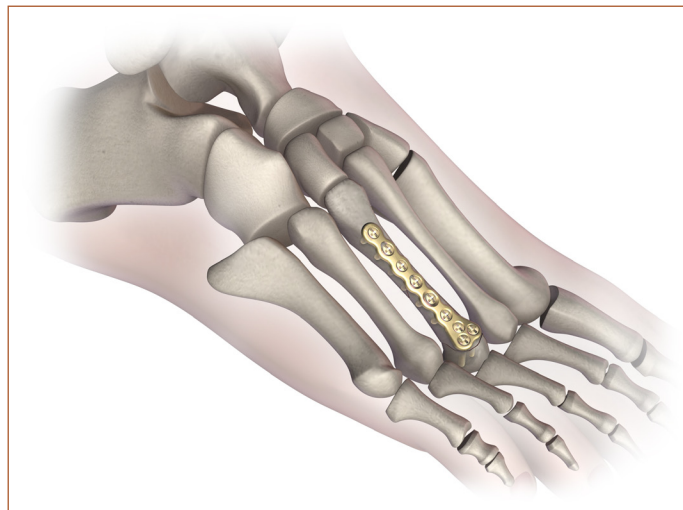





*Rethinking Possibilities, Reshaping Lives*

**OSTEOMED**

3885 Arapaho Rd.  
Addison, TX 75001

Customer Service: 800.456.7779

Outside the U.S.: 001.972.677.4600

Fax: 800.390.2620

Fax Outside the U.S.: 001.972.677.4709

E-mail: [customer.service@osteomed.com](mailto:customer.service@osteomed.com)

[www.osteomed.com](http://www.osteomed.com)